



Montecito Debris Flow Mitigation Project



Master Work Plan

-October 25, 2018-

PREPARED FOR:



THE PARTNERSHIP
FOR RESILIENT COMMUNITIES

The Partnership for Resilient Communities

Table of Contents

1.0 PROJECT UNDERSTANDING	3
2.0 PROJECT COST	3
3.0 DEBRIS FLOW MITIGATION TECHNICAL APPROACH	5
3.1 DEBRIS RETENTION NET INSTALLATION	5
3.2 DEBRIS RETENTION NET MAINTENANCE.....	5
3.3 ACCUMULATED DEBRIS MANAGEMENT	5
3.4 REMOVAL OF DEBRIS RETENTION NETS.....	6
4.0 DEBRIS NET SITE-SPECIFIC WORK PLANS.....	6
4.1 BUENA VISTA CANYON DEBRIS NET WORK PLANS	7
4.1.1 Debris Net BV-2.....	7
4.1.2 Debris Net BV-4.....	9
4.1.3 Debris Net BV-5.....	10
4.1.4 Debris Net BV-6.....	11
4.1.5 Debris Net BV-7.....	12
4.1.6 Debris Net BV-10.....	13
4.1.7 Debris Net BV-11.....	14
4.2 HOT SPRINGS CANYON DEBRIS NET WORK PLANS	15
4.2.1 Debris Net HS-6.....	15
4.2.2 Debris Net HS-7.....	16
4.3 COLD SPRINGS CANYON DEBRIS NET WORK PLANS.....	17
4.3.1 Debris Net CS-11	17
4.3.2 Debris Net CS-18	18
4.4 SAN YSIDRO CANYON DEBRIS NET WORK PLANS	19
4.4.1 Debris Net SY-7.....	19
4.4.2 Debris Net SY-18.....	20
4.5 ROMERO CANYON DEBRIS NET WORK PLANS	21
4.5.1 Debris Net RC-12.....	21
4.5.2 Debris Net RC-15.....	22
5.0 EMERGENCY ACTION PLAN.....	23
6.0 REMARKS	23

Attachments

Attachment A – Equipment Data Sheets

Attachment B – Material Data Sheets

Attachment C – Emergency Action Plan

1.0 PROJECT UNDERSTANDING

The debris flow events of early January 2018 greatly impacted the Community of Montecito. Access Limited Construction (ALC) understands that The Partnership for Resilient Communities (PRC) is preparing to obtain permits for the construction of debris retaining nets in the watersheds that drain the Santa Ynez Mountains above Montecito to mitigate hazards to the community from future debris flow events while the watersheds recover from the changes due to the Thomas Fire.

Kane Geotech, Inc. has developed recommendations and engineered designs for debris retention nets at locations in Buena Vista Canyon, Hot Springs Canyon, Cold Springs Canyon, San Ysidro Canyon, and Romero Canyon. The Partnership for Resilient Communities has requested a work plan from ALC detailing our pricing, as well as our proposed work plans for the installation, debris removal, maintenance, and removal of these debris nets.

Access Limited Construction has a detailed understanding of the project and realizes the magnitude of what is at stake for the community of Montecito. Kane Geotech has finalized the design documents for the project. ALC has visited the site with the project team and has had numerous conversations with Kane Geotech regarding constructability and project constraints.

We recognize the importance of balancing the environmental and social stewardship of these watersheds with the need for debris flow hazard mitigation to the Community of Montecito. Of particular note is the federally designated fish species habitat identified in the streams proposed for debris flow mitigation. The net designs call for a minimum elevation of three feet above the low-flow stream channel to allow natural stream processes and wildlife use of the riparian corridor at all times except for during flood (high flow)/debris flow events. We have tailored our means and methods by critically evaluating any potential impacts to aquatic species and ensuring that every step of the process minimizes potential impacts and includes measures to protect fish, wildlife and plant resources. The individual work plans we have developed for each debris retention net site reflect a thoroughly vetted approach to minimizing the impacts of this work on the environment.

To that end, this Master Work Plan has been developed based on the experience of Access Limited Construction personnel and a detailed understanding of the emergency project considerations. We have framed our approach to minimize the environmental impacts of the debris flow mitigation work. We also recognize the importance of urgent installation prior to the upcoming rainy season to protect the lives, health, and property of residents, and essential public services, from the clear and imminent danger of debris flows. Notably, Access Limited has extensive experience installing, maintaining, managing accumulated debris, and removing debris nets throughout the arid western United States following wildfire events in mountainous terrain. We present our pricing and master work plan below.

2.0 PROJECT COST

The table below details the pricing for installation, accumulated debris management, maintenance, and removal for each debris retention net location. The underlying spreadsheets and work papers for this pricing are being reviewed by the PRC's financial staff and may be subject to change for performance bonding purposes.

3.0 DEBRIS FLOW MITIGATION TECHNICAL APPROACH

Access Limited Construction personnel participated in a site visit during the week of September 24, 2018 to perform layout of the debris nets at the locations identified by Kane Geotech. This effort was performed with a team including PRC personnel, Kane Geotech personnel, and Storrer Environmental Services (SES) personnel. As a result, we have developed work plans for each debris net location that reflect a desire to minimize environmental impacts and expedite the emergency timeframe for installation. We have included with this proposal information detailing the equipment we are proposing to use in the work plans below as *Attachment A – Equipment Datasheets*. In addition, we are providing information detailing the material we are proposing to use as *Attachment B – Material Datasheets*. *Attachment C – Emergency Action Plan* details the criteria and protocols for reacting to a forecast precipitation event impacting the work areas. The Emergency Action Plan also includes a project map that details access routes for ingress/egress from the work areas, as well as safe landing zones for emergency evacuation protocols. The ingress/egress points are via public roadways and are within the County of Santa Barbara Public Works Right of Way. It is expected that an encroachment permit from the County will be obtained prior to mobilization.

3.1 Debris Retention Net Installation

The basic sequence to install the debris retention nets involves mobilizing equipment, personnel, and materials to the work area, installing and testing verification anchors, installing cable anchors in the stream banks, assembling the cable infrastructure and nets across the channel, and finally demobilizing the equipment, personnel, and any remaining material from the work area. Notably, the installation design does not impede upon the low-flow channel area and no work will occur within the wetted (low-flow) area of the stream. We will use a biological monitor during the installation work to monitor operations. All equipment will be power washed prior to mobilization. Based upon location in the drainages, and distance from access roads, we have identified a basic approach to mobilizing and demobilizing equipment for installation. The approach for delivery at these sites is described in the work plan below. The approach entails aerial transport of the drilling & grouting equipment to each work area followed by the site-specific net material.

3.2 Debris Retention Net Maintenance

The approach to performing maintenance of the debris retention nets will depend on the degree of maintenance required. Annual or post-event inspection and documentation of the net condition can be accomplished by personnel hiking to the site. If minor maintenance (tightening cables, replacing components, etc.) needs to be performed, tools and materials can either be carried by personnel, or transported by light or medium duty helicopter. If major maintenance is required and equipment is needed to perform the task, the approach to mobilizing equipment will be the same as for installation.

3.3 Accumulated Debris Management

The intent of this approach is to minimize impacts to the environment while maintaining emergency debris retention capacity. Due to a focus on maintaining fish passage, management of accumulated debris at each retention net site after debris flow events will be by reestablishing the low-flow channel down to the base of the pre-event stream channel. This portion of the work would be done under the observation of a biological monitor to ensure best practices are followed.

Should a flow occur, water flow levels in the drainage will be monitored until a normal flow rate is reestablished. After the flowrate has normalized, a Spyder excavator or a 10-ton class excavator will be flown to the worksite via heavy-lift helicopter. The excavator will re-establish the channel

starting from the back of the drainage working towards the net. As more delicate operations are required to reestablish the low-flow channel, clearing accumulated material from the pre-event stream channel may be finished by hand. The material excavated during reestablishment of the low-flow channel will be handled by placing the excavated material downstream over the debris retention net in a manner that does not impede on the low flow channel. No sediment will be taken out of the riparian area but instead will be placed to allow natural erosion ultimately to the beaches to occur during high flow events. A biological monitor will be onsite to monitor this portion of the work. Best Management Practices and protocols are being developed by SES for this work task. Access Limited Construction has corresponded with SES regarding these protocols and considers them to be feasible to implement for the project.

If very large boulders are present in the retention area which are blocking the low flow channel, they can be broken by mechanical means (hydraulic rock splitters) for placement outside the low-flow channel or as directed by the biological monitor.

If large organic (woody) debris is present and poses an issue to reestablishing the low-flow channel, a portable wood chipper can be mobilized to the work area to chip the organic debris and place outside of the stream channel or as directed by the biological monitor.

3.4 Removal of Debris Retention Nets

We understand that when the watersheds have recovered to an extent where there is no longer an expected risk of debris flows, it is desirable to remove the debris retention nets. Removal of debris nets will entail excavating accumulated debris with a Spyder excavator from the area immediately behind the net to relieve pressure from the net and cable infrastructure. The Spyder excavator will be mobilized with the same approach as installation at a given site. The net will be removed from the infrastructure and the cables removed from the anchors. These materials will be packaged for aerial transport out of the canyon.

The wire rope anchors will be cut off below grade and concealed with native soil and rocks to leave no visual trace.

When the final demobilization is complete, the site will be left with the low-flow channel established to enable fish passage. We will use a biological monitor during the removal work to monitor operations. Any remaining debris in the stream channel after the removal of the debris nets will then be subject to natural erosion to the beaches by high flow events as part of the natural sediment regime of the watershed.

4.0 DEBRIS NET SITE-SPECIFIC WORK PLANS

The following sections of this document detail the proposed site-specific work plan for mobilization, construction, management of accumulated debris, and removal of debris nets at each location identified by Kane Geotech. The work plan for the BV-1 debris retention net site is detailed below. The remaining sites will use the same approach. The sites are organized into sub headings based on the watershed they are in and include a site photo.

4.1 Buena Vista Canyon Debris Net Work Plans

4.1.1 Debris Net BV-2

Net Type	Approach Type	Retention Volume (Cubic Yards)
VX140-H4	Aerial Transport	1309



Site BV-2 Photo by Kane Geotech (2018.05.29)

- **Construction**

Construction activities at each site will be fully supported by medium to heavy lift helicopter. Personnel will hike to this location daily to perform the work. Prior to the installation of production anchors, sacrificial anchors will be installed in the same manner and tested. The test will be conducted by first placing timber cribbing on either side of the anchor head spanning with an engineered beam and pulling the anchor to a prescribed load. A mobile drill with an air rotary percussion drill will be used to advance borings for anchorages. Drill cuttings and dust will be controlled with wet dust suppression methods (misting). Equipment for drilling will use biodegradable lubricants and fluids. Fueling will be accomplished by aerial transport of diesel fuel for the equipment on an as-needed basis. No fuel will be stored at the work area and all equipment will utilize secondary containment for fueling operations. Compressed air will be provided at the site by running air lines from compressors staged at the access route (trailhead).

Construction materials will be transported via aerial transport utilizing a medium to heavy helicopter. The materials list includes wire rope anchors, cement grout, potable water, wire rope infrastructure, ring net panels, and braking elements.

Mobilization of grouting equipment will also be via aerial transport. A portable grout plant (mixer and pump unit) will be set up at the work location, complete with secondary containment vessel to prevent any unintended material contact with the native ground. The grout plant will be set up at least 15-ft from any flowing water. A biological monitor will monitor the grouting operations. Grouting operations will be planned and monitored carefully to ensure that no grout spillage occurs. Secondary containment will be set up around anchor locations to ensure that no unintended grout-ground contact is possible.

- **Accumulated Debris Management**

After a debris flow event occurs, an assessment of the accumulated debris will be made. The timeframe for assessment and implementation of the debris management work will be dependent on the stream flow conditions and the precipitation forecast. No assessment or debris management work will occur until it is considered safe to return to the work area. A biological monitor will be onsite to monitor this portion of the work. If significant organic debris is present, a portable wood chipper will be mobilized to the work area. The wood chipper will be used to chip and spread the organic debris outside of the channel in the vicinity of the work area. A Spyder excavator or a 10-ton class excavator will be mobilized to the site by aerial transport via heavy lift helicopter. The excavator will be used to reestablish the low-flow channel through the accumulated debris and will handle the excavated debris according to the approved protocol. Once the low-flow channel is reestablished and the debris is managed, the Spyder excavator will demobilize via aerial transport to another work area. If very large boulders are present in the retention area which are blocking the low flow channel, they can be broken by mechanical means (hydraulic rock splitters) for placement outside the low-flow channel.

- **Maintenance**

The approach to performing maintenance of the debris retention nets will depend on the degree of maintenance required. Annual or post-event inspection and documentation of the net condition can be accomplished by personnel traversing to the site. If minor maintenance (tightening cables, replacing components, etc.) needs to be performed, tools and materials can either be carried by personnel, or transported by light or medium duty helicopter. If major maintenance is required and equipment is needed to perform the task, the approach to mobilizing equipment will be the same as for installation.

- **Debris Retention Net Removal**

Removal of debris nets will entail excavating accumulated debris with a Spyder excavator from the area immediately behind the net to relieve pressure from the net and cable infrastructure. The Spyder will be mobilized by aerial transport via heavy lift helicopter to the work area. The net will be removed from the infrastructure and the cables removed from the anchors. These materials will be packaged for aerial transport out of the canyon. For anchors installed in bedrock or boulders, the exposed portions will be cut off at the ground surface and obscured by covering in sculpted concrete designed to blend in with the native environment. For anchors installed in soil, they will be cut off below the ground surface and covered with native soil.

4.1.2 Debris Net BV-4

Net Type	Approach Type	Retention Volume (Cubic Yards)
SVX180-H6	Aerial Transport	7205



Site BV-4 Photo by Kane Geotech (2018.05.29)

4.1.3 Debris Net BV-5

Net Type	Approach Type	Retention Volume (Cubic Yards)
VX140-H4	Aerial Transport	1873



Site BV-5 Photo by Kane Geotech (2018.05.29)

4.1.4 Debris Net BV-6

Net Type	Approach Type	Retention Volume (Cubic Yards)
VX160-H6	Aerial Transport	2345



Site BV-6 Photo by Kane Geotech (2018.05.29)

4.1.5 Debris Net BV-7

Net Type	Approach Type	Retention Volume (Cubic Yards)
VX160-H6	Aerial Transport	6927



Site BV-7 Photo by Kane Geotech (2018.05.29)

4.1.6 Debris Net BV-10

Net Type	Approach Type	Retention Volume (Cubic Yards)
VX160-H6	Aerial Transport	4481



Site BV-10 Photo by Access Limited (2018.09.25)

4.1.7 Debris Net BV-11

Net Type	Approach Type	Retention Volume (Cubic Yards)
SVX180-H6	Aerial Transport	14420



Site BV-11 Photo by Access Limited (2018.09.25)

4.2 Hot Springs Canyon Debris Net Work Plans

4.2.1 Debris Net HS-6

Net Type	Approach Type	Retention Volume (Cubic Yards)
SVX180-H6	Aerial Transport	12868



Site HS-6 Photo by Kane Geotech (2018.05.29)

4.2.2 Debris Net HS-7

Net Type	Approach Type	Retention Volume (Cubic Yards)
VX140-H4	Aerial Transport	1742



Site HS-7 Photo by Kane Geotech (2018.05.29)

4.3 Cold Springs Canyon Debris Net Work Plans

4.3.1 Debris Net CS-11

Net Type	Approach Type	Retention Volume (Cubic Yards)
VX160-H6	Aerial Transport	3848



Site CS-11 Photo by Kane Geotech (2018.05.29)

4.3.2 Debris Net CS-18

Net Type	Approach Type	Retention Volume (Cubic Yards)
SVX180-H6	Aerial Transport	5782



Site CS-18 Photo by Kane Geotech (2018.05.29)

4.4 San Ysidro Canyon Debris Net Work Plans

4.4.1 Debris Net SY-7

Net Type	Approach Type	Retention Volume (Cubic Yards)
SVX180-H6	Aerial Transport	8472



Site SY-7 Photo by Kane Geotech (2018.05.29)

4.4.2 Debris Net SY-18

Net Type	Approach Type	Retention Volume (Cubic Yards)
SVX180-H6	Aerial Transport	6184



Site SY-18 Photo by Kane Geotech (2018.05.29)

4.5 Romero Canyon Debris Net Work Plans

4.5.1 Debris Net RC-12

Net Type	Approach Type	Retention Volume (Cubic Yards)
SVX180-H6	Aerial Transport	2688



Site RC-12 Photo by Kane Geotech (2018.05.29)

4.5.2 Debris Net RC-15

Net Type	Approach Type	Retention Volume (Cubic Yards)
VX160-H6	A -Traverse	1256



Site RC-15 Photo by Kane Geotech (2018.05.29)

5.0 EMERGENCY ACTION PLAN

Given the unique emergency work locations in active stream channels subject to debris flow hazards, Access Limited Construction recognizes that an Emergency Action Plan is a prudent and necessary part of this project. Accordingly, we have developed a written procedure detailing the criteria for enacting the response to a potential hazard event during construction activities at the watershed locations proposed for debris flow mitigation. This plan is attached to this proposal as *Attachment C*. We are familiar with the Santa Barbara County Office of Emergency Management and have incorporated their emergency plan into our response plan.

We have established a protocol that reflects a temporal response based on the precipitation forecast (48 hours prior to a measurable event). The protocol establishes demobilization from the work area via helicopter or physically traversing out of the stream channel and securing equipment and materials on high ground above inundation areas. The BMPs will be installed at each work area prior to commencing construction activities. Materials required to maintain the BMPs will be transported to the work area by aerial transport via light or medium duty helicopter. Any BMP maintenance required prior to evacuating during the enactment of the Emergency Action Plan will be implemented prior to departing the site. BMP implementation/maintenance is considered to be a part of the normal work day and is not anticipated to increase the timeframe for evacuation.

6.0 REMARKS

This Master Work Plan was compiled based on our experience and understanding of the project requirements and can be modified to accommodate any concerns not addressed herein or suggestions to optimize the approach given project constraints and considerations. We recognize that a key component of this project is approval of the necessary permits. As a result, our means and methods for installation, maintenance, and removal reflect a well-planned approach to minimizing environmental impacts while focusing on expediting the installation timeframe due to the emergency nature of the project.

The management of accumulated debris retained in the nets is a crucial aspect of this project. The efficacy of the debris retaining nets lies in the ability to maintain retention capacity between debris flow events. We recognize the complex balance of maintaining the natural sediment regime within these watersheds with the need to mitigate or prevent imminent debris flow hazards to the Community of Montecito. Based on our experience, the approach outlined in this proposal provides a best-case scenario to serve both needs. We appreciate the opportunity to be of service. Please do not hesitate to contact us with any questions or concerns.

Respectfully,

Access Limited Construction

Brian McNeal
President

Kevin Wiesman
Vice President

Simon Boone, PG
Project Manager



Attachment A -Equipment Datasheets-

S12 ALLROAD

Digging envelope KAISER S12 Allroad

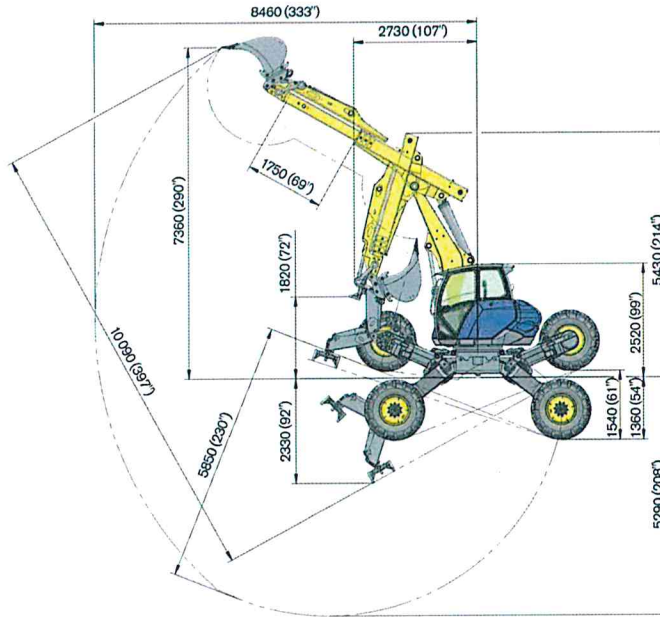

Digging envelope KAISER S12 4x4

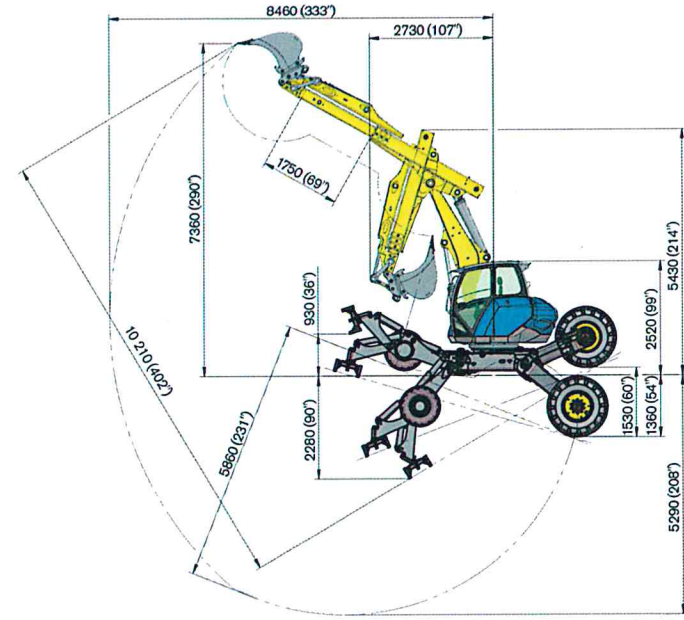

Undercarriage KAISER S12 Allroad

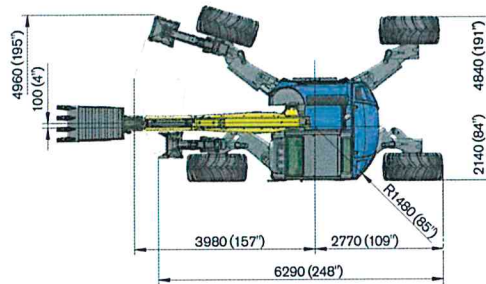

Undercarriage KAISER S12 4x4

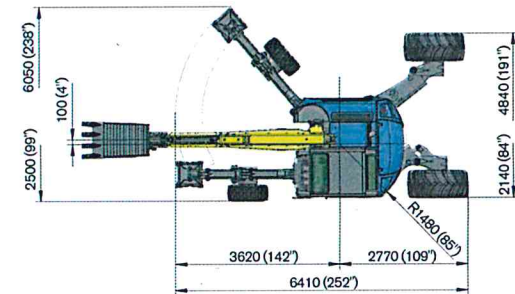

TECHNICAL SPECIFICATIONS

Engine

Perkins 1204E-E44TA Torque	max. Leistung	110 kW / 150 hp @ 2000 rpm 560 Nm @ 2000 rpm
HP engine version Perkins 1204E-E44TTA Torque	max. Leistung	129 kW / 175 hp @ 2000 rpm 750 Nm @ 1400 rpm
Displacement		4400 ccm
Emissions standard		EU 97/68 Stage IIIB US EPA Tier 4i
Voltage		24 volts
Cooling system		4-circuit cooling system, coolers arranged side by side with reversible fan drive for cleaning coolers
Breakout force		100.5 kN
Ripping force		71 kN
Diesel tank capacity (fuel tank / reserve tank)		
> S10 und S12 4x4		410 litres (140 l / 270 l)
> S12 Allroad		280 litres (140 l / 140 l)
Service interval		500 operating hours

Hydraulics

Flow rate, working pump	max. 290 litres/min	320 bar
Flow rate, drive pump	max. 170 litres/min	400 bar
Flow rate, fan pump	max. 40 litres/min	200 bar
ROTOline	max. 220 litres/min	350 bar
Hydraulic system capacity	200 litres	
Slewing speed (power / speed)	5 rpm, 10 rpm	
Slewing torque	55 000 Nm	
Slewing ring	module 10	
Travel speed	infinitely variable, 0-15 km/h, depending on type and tyre size	

Weight		
> S10		From 11 000 kg
> S12 4x4		From 12 000 kg
> S12 Allroad		From 13 000 kg
Cabin		ROPS ISO 12117 / FOPS ISO 10262
Cylinder		with joint bearings, all pulling loads leakage-free

Lifting capacity	S10	S12 Allroad
3 m	7700 kg	9200 kg
4 m	5500 kg	6500 kg
6 m	3300 kg	4000 kg



Perkins 1104D-E44TA max. power	116.9 kW/157 PS	
Performance characteristics T3028	106 kW/144 PS @ 2200 rpm	
Torque	556 Nm @ 1400 rpm	
Displacement	4400 ccm (268 cu inches)	
Emission standard	EC Standard 97/68/EC Stage 3A US EPA 40 CFR 89 Stage 3	
Starter	4.2 kW	
Alternator	85 A	
Battery	2x70 Ah - 760 A	
Sound pressure	L _{pA} 75 dB(A)	
Sound level	L _{WA} 99 dB(A)	
Cooling system	5-circuit cooling system	
Max. ambient temperature	46°C (115° F)	
Tank capacity diesel (tank/chassis tank)	396 l (120 l/276 l)	104.6 gal (31.7 gal/72.9 gal)
Hydraulic system capacity (tank)	200 l (140 l)	52.8 gal (37 gal)
Slewing rate (powerful/fast)	4 rpm; 9 rpm	
Slew torque	48000 Nm	
Rotation crown wheel	Module 10	
Working transverse to slope	70%	
Working longitudinally to slope	100%	
Turning circle	13 m (42' 6")	
Travelling speed (powerful/fast)	0-6 km/h; 0-10 km/h (0-4 mph; 0-6.2 mph)	
Climbing ability on roads up to	50%	
Tensile strength	69 kN (ISO 6015)	
Breakaway torque	92 kN (ISO 6015)	
Lifting power	3 m/55 kN (5.5 t)	9' 10"/55 kN
	5 m/28 kN (2.8 t)	16' 5"/28 kN
	7 m/16 kN (1.6 t)	22' 12"/16 kN
Weight	From 9'980 kg (22.000 lb)	
Cab	ROPS/FOPS DIN ISO 3471 and DIN 24090	

Options

S2		
Front tyres "wheel"	385/45-14.25 (d=850mm/2' 8"; b=385mm/1' 2") - STANDARD	
	400/55-17.5 (d=850mm/2' 8"; b=400mm/1' 3")	
Rear tyres "driving wheel"	52x20.5-20 (d=1280mm/4' 2"; b=525mm/1' 8") - STANDARD	
	600/50-22.5 (d=1170mm/3' 10"; b=600mm/1' 11")	
	600/50-26.5 (d=1330m /4' 4"; b=600mm/1' 11")	

227052007

Technical changes are possible without further notice!

Dok-ID 93066B-

www.kaiser.li



KAISER AG Fahrzeugwerk
Vorarlbergerstrasse 220
LI-9486 Schaanwald

Phone +423-377 21 21
Fax +423-377 21 10
kaiserag@kaiser.li



Rugged design

Undercarriage

Solid undercarriage, large dimension bearings, surface treated bolts and bronze bushings guarantee maximum life span. Optimised weight distribution with low gravity center for maximum stability in difficult terrain. Well protected hose guides, generally integrated in steel.

Boom

Heavy Duty boom with long reach and excellent load lifting capacity, which can be fully utilized due to high stability. Centering fix for quick and easy bucket change. Solid connecting rod and shear. All bolts on boom screwed. Advertising board on left and right on boom. Boom piping arranged for optimal protection of hydraulic hoses. Five hydraulic connections for accessories such as hydraulic tilt bucket, hammer and grapple bucket.

Hydraulic cylinders

All boom cylinders are provided with end position damping and spherical joint bearing. Cylinders in undercarriage are provided with spherical joint bearings and hose fracture safety valves to ensure that the excavator maintains its position in the event of a failure.

Top performance

Slewing drive

Torque controlled 360° continuous slewing drive with 48kNm. Axial piston variable speed motor with two operating modes for fast (0-9 rpm) and powerful (0-4 rpm) slewing with maximum positioning accuracy. Two-speed planetary gearing with automatic disc brake in oil bath. Rugged ball bearing slewing ring module type 10 with hardened tooth profiles.

Drive

Closed hydraulic circuit with separate pump for maximum performance. Driving and working movements can be performed simultaneously. Precise handling through power control.

Axial piston variable speed motor with two operating modes for fast (0-10 km/h / 0-6.2 mph) and powerful (0-6 km/h / 0-4 mph) driving with maximum handling precision.

Two-speed planetary gearing with disc brake in oil bath. The parking brake is manually operated via joystick for easy manoeuvrability.

Mobility

Maximum mobility with intelligent all-wheel steering kinematics. Small turning circle and excellent track precision over the entire adjustment range.

Precise movement in terrain without damage. Various steering modes displayable: Front wheel, rear wheel, all-wheel steering or dog steering. KAISER models can also be approved for road traffic use.

Engine

Perkins (CAT) 4-cyl. diesel engine, type 1104D-E44TA. 116.9 kW (157PS); 556 Nm at 1400 rpm. Electronically controlled; ACERT Common Rail injection system, exhaust standard 97/68/EC Stage IIIA or US EPA Stage 3. Control of injection system by original Perkins (CAT) ECU control system. The most powerful and high-torque diesel engine in its class, thanks to 4-valve technology.

Fig: Torque characteristic Perkins 1104D-E44TA

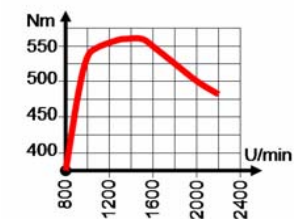

Electrical system

12V, battery 2x70Ah, alternator 85A, starter 4.2kW. Three working lights for excellent illumination. Horn, parallel wipers with washer/wiper system and parking position "Emergency stop switch", radio with CD. Electronic fan and engine management.

Cooling system

5-circuit cooling system for hydraulic oil, cooling water, charge air, diesel fuel and air conditioning. The electronic fan management ensures optimal temperatures at all times, reduces fuel consumption and maintains noise at a low level. Worldwide approval up to ambient temperatures of 46°C (115° F) at maximum power. Coarse and fine filters protect the easy to clean radiator.

Precise hydraulics

Bosch Rexroth LUDV Load Sensing Hydraulics. The system operates with a power-controlled swash plate axial piston pump.

Operating pressure 300 bar (4350 psi); 190 litres/min. (50 gal/min) for powerful movement. Regenerative function for fast and powerful movement, including priority control for slewing mechanism. Drive in 400 bar (5800 psi) closed circuit; 140litres/min. (37 gal/min) is operated via a swash plate axial piston pump.

The geared pump with a capacity of 45 litres/min. (12 gal/min) supplies the hydraulic fan, secondary flow filtration and cooling.

Maximum comfort

Control

Futura® joystick in an optimal ergonomic design for left and right-hand use; guaranteed functionality and reliability. All functions can be selected directly via the joystick, no release of the control necessary (brake, display switching and speed selection). Three ergonomically arranged pedals for actuating telescopic, driving and additional connection. Plenty of leg room and foot support options including foot rail.

Toggle switch for speed selection, slewing fast/powerful, washer/wiper system, working light.

Cab

Comfortable, safety cab with wide door, clear all-round view and plenty of legroom. ROPS and FOPS test according to DIN ISO 3471 and DIN 24090. Continuous inward opening windshield, (without cross member) ensures clear all-round view. Glass roof for maximum visibility.

Low vibration and noise level due to hydraulic suspension and hermetic insulation (Engineered in cooperation with research Universities and Institutions). Air-suspension seat with high backrest and numerous adjustment options. Roof sunblind.

Hydraulic one-hand cab tilting device.

Instrument panel

Instrument panel with multifunction display for all important operating states:

Engine speed, operating hour meter, hour meter, fuel gauge, hydraulic oil temperature, water temperature, alarm, battery charge indicator, engine oil pressure, emergency stop and overload display.

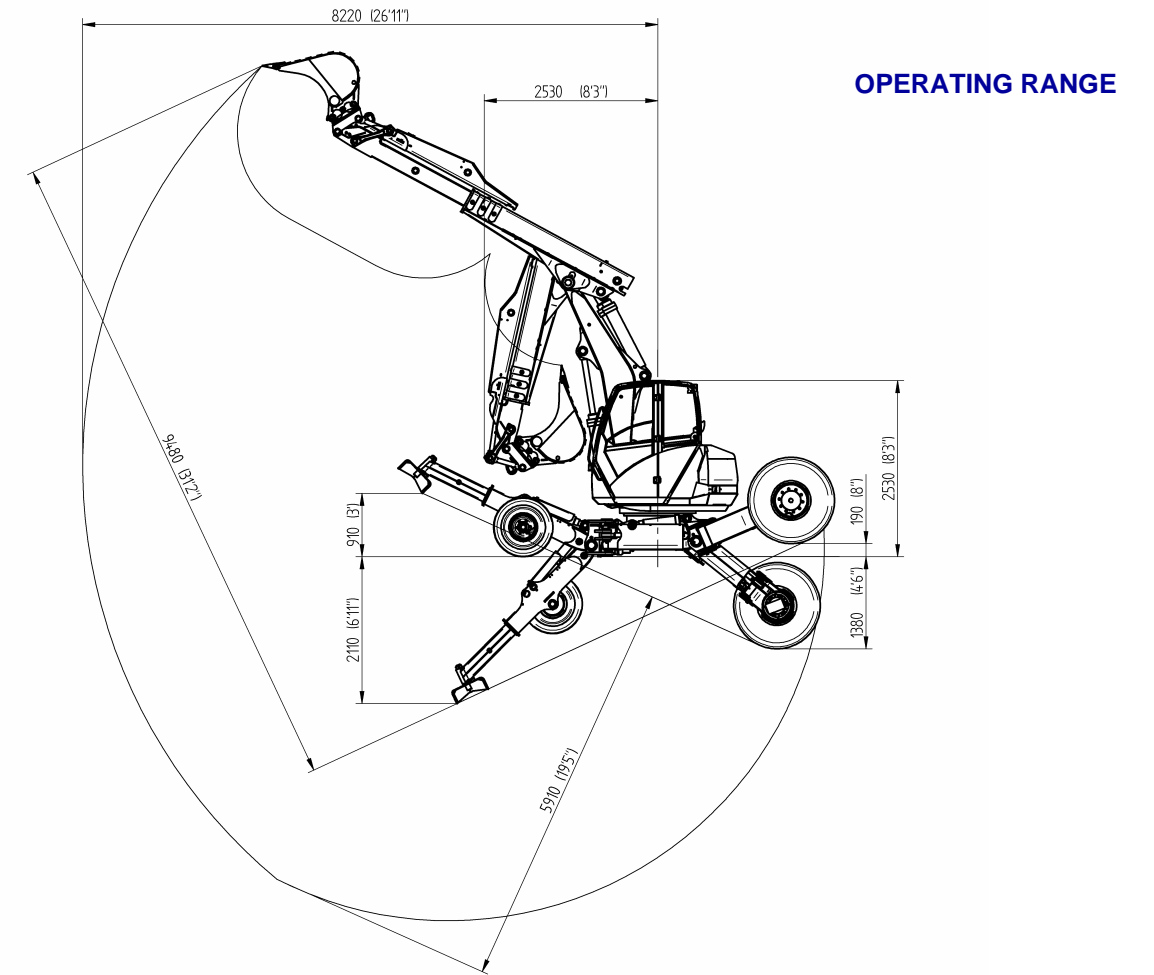

OPERATING RANGE

TRANSPORT

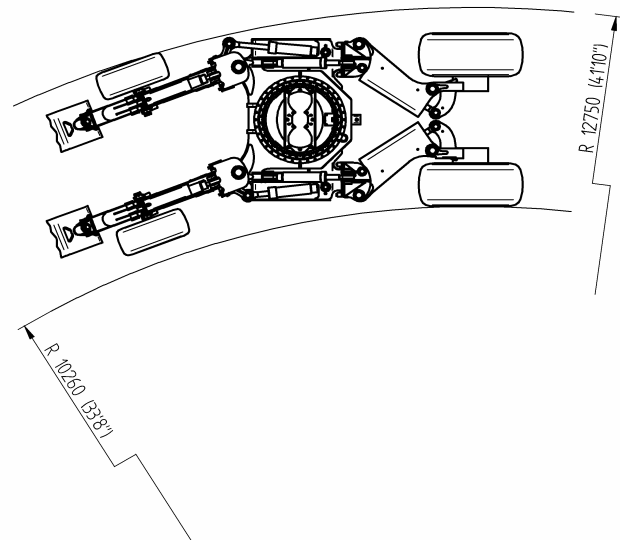
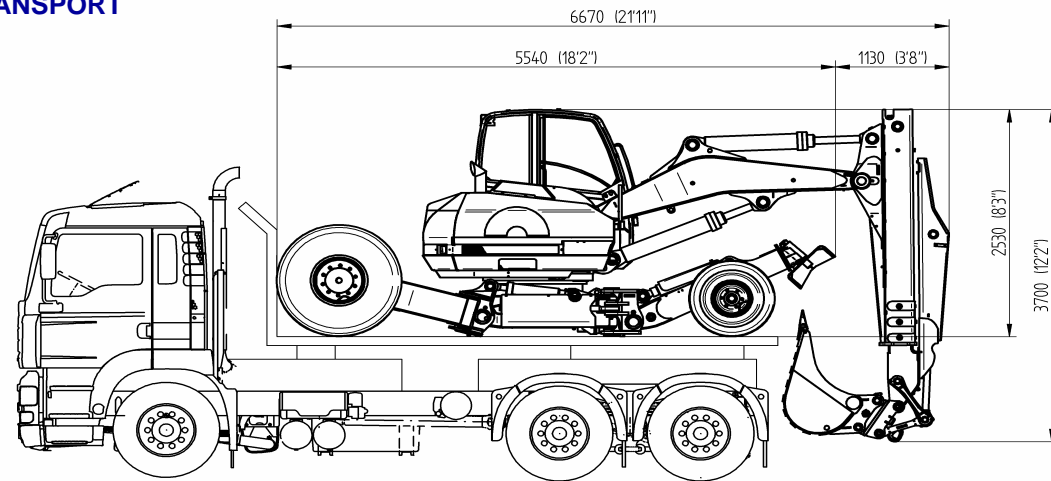

WITHOUT ALL-WHEEL STEERING

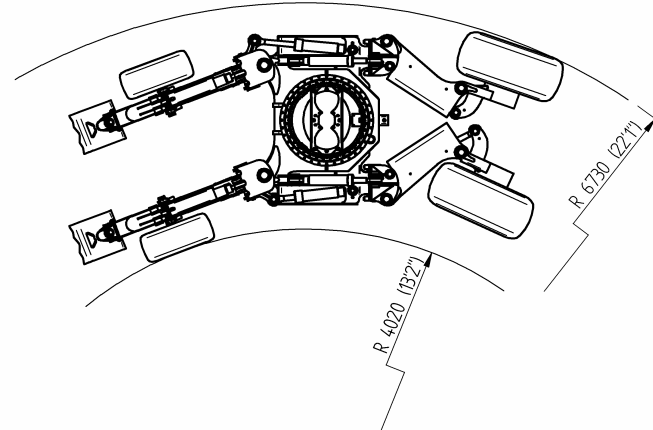

WITH ALL-WHEEL STEERING

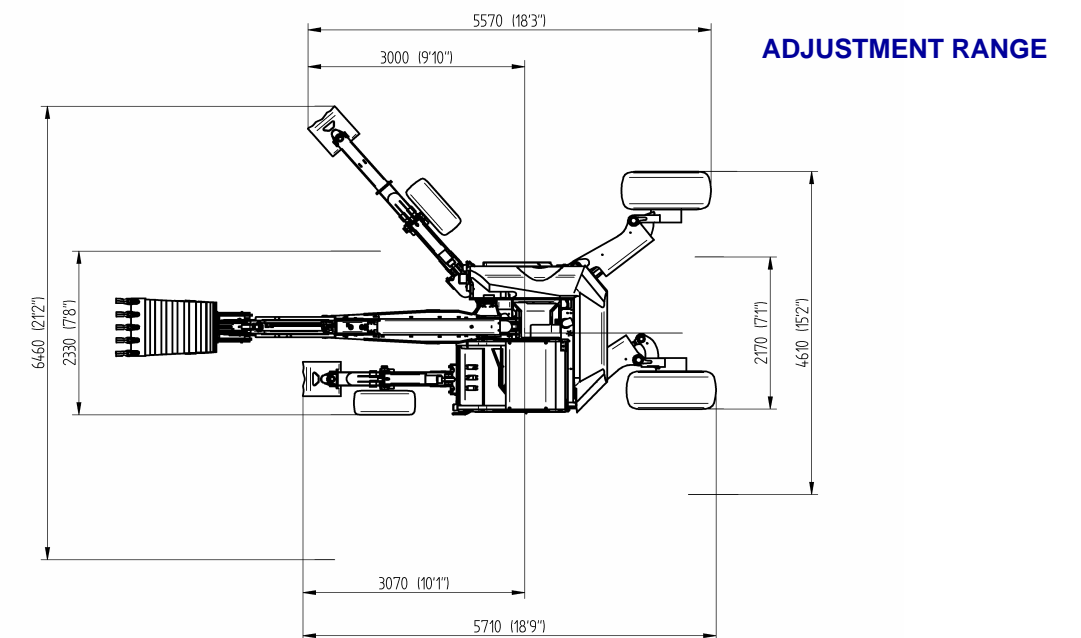

ADJUSTMENT RANGE

308C CR Hydraulic Excavator

Dimensions

All dimensions are approximate.

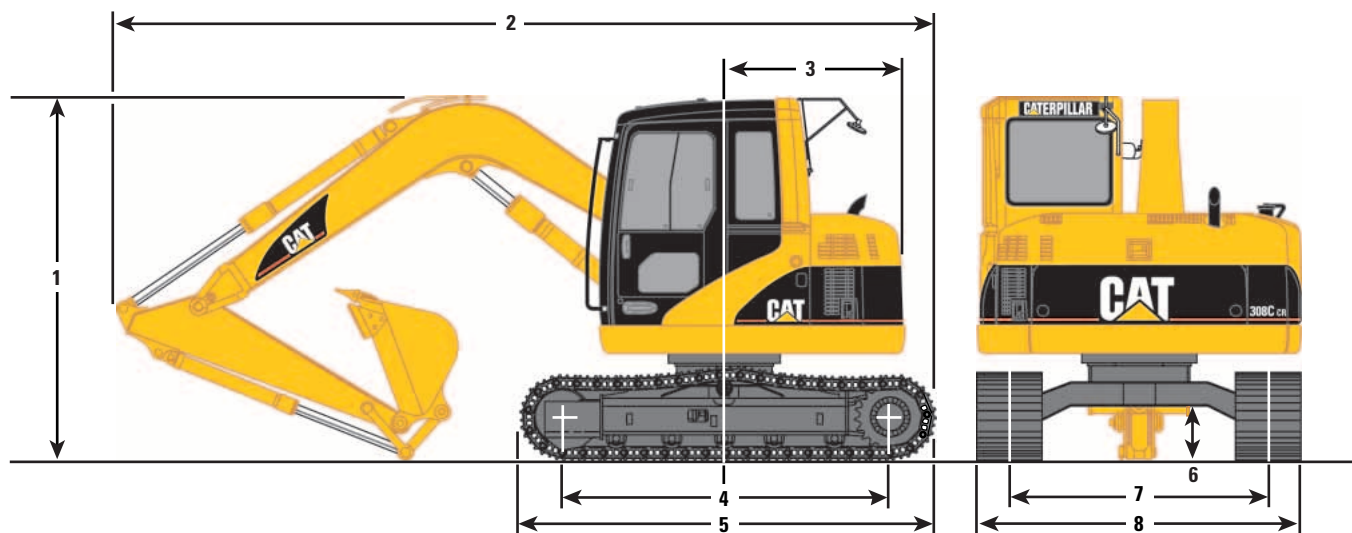

Boom 3.7 m (12'2")	1665 mm (5'6") Stick	2210 mm (7'3") Stick
1 Shipping height	2610 mm (8'7")	2740 mm (9'0")
2 Shipping length	5830 mm (19'2")	5850 mm (19'2")
3 Tail swing radius	1290 mm (4'3")	1290 mm (4'3")
4 Length to centers of rollers	2280 mm (7'6")	2280 mm (7'6")
5 Track length	2910 mm (9'7")	2910 mm (9'7")
6 Ground clearance	384 mm (15")	384 mm (15")
7 Track gauge	1870 mm (6'2")	1870 mm (6'2")
8 Transport width		
450 mm (18") shoes	2320 mm (7'7")	2320 mm (7'7")
600 mm (24") shoes	2470 mm (8'1")	2470 mm (8'1")

Operating Weights

Caterpillar designed and built track-type undercarriage.

Track width	Operating Weight (medium stick)		Operating Weight (long stick)	
standard 450 mm (18") triple grouser	7430 kg	(16,370 lb)	7470 kg	(16,470 lb)
optional 600 mm (24") triple grouser	7600 kg	(16,760 lb)	7650 kg	(16,860 lb)
2320 mm Blade: add	380 kg	(850 lb)		
2470 mm Blade: add			390 kg	(870 lb)
With 450 mm (18") Segmented Rubber Track: add	23 kg	(100 lb)		

308C CR Hydraulic Excavator

Working Ranges

Feet Meters

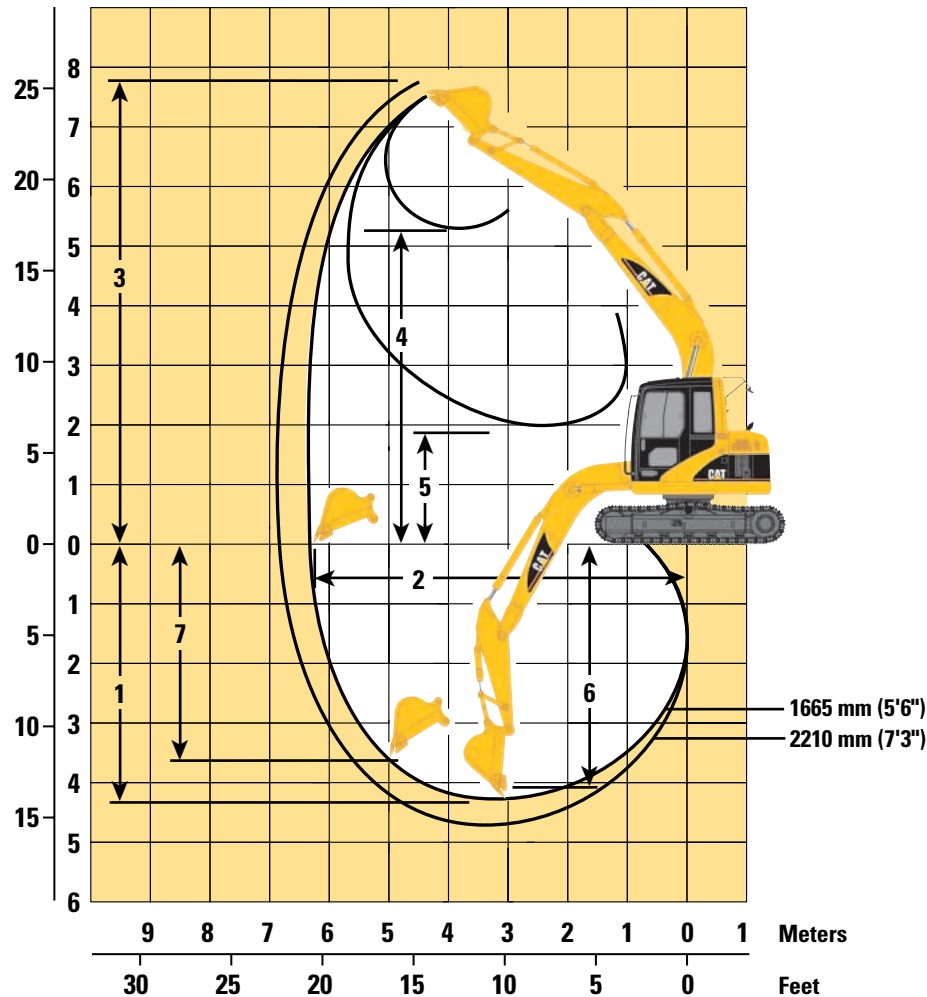

Stick Length	1665 mm (5'6")	2210 mm (7'3")
1 Maximum Digging Depth	4140 mm (13'7")	4690 mm (15'5")
2 Maximum Reach at Ground Level	6250 mm (20'6")	6770 mm (22'3")
3 Maximum Cutting Height	7390 mm (24'3")	7810 mm (25'7")
4 Maximum Loading Height	5250 mm (17'3")	5670 mm (18'7")
5 Minimum Loading Height	2400 mm (7'10")	2060 mm (6'9")
6 Maximum Depth Cut for 2440 mm (8') Level Bottom	3800 mm (12'6")	4380 mm (14'4")
7 Maximum Vertical Wall Digging Depth	3600 mm (11'10")	4120 mm (13'6")
Minimum Front Swing Radius	1660 mm (5'5")	2180 mm (7'2")
Stick Digging Force (SAE)	35 kN (7850 lb)	31 kN (6880 lb)
Bucket Digging Force (SAE)	44 kN (9820 lb)	44 kN (9840 lb)

308C CR Hydraulic Excavator

Buckets

Buckets have tapered sides, angled corner teeth, dual radius curvature, horizontal wear strips, and holes for optional side cutters.

Width		Capacity		Recommended Maximum Material Density			
				Medium Stick		Long Stick	
mm	in	m ³	yd ³	kg/m ³	lbs/yd ³	kg/m ³	lbs/yd ³
460	18	0.15	0.2	1800	3000	1800	3000
610	24	0.23	0.3	1800	3000	1800	3000
760	30	0.31	0.4	1800	3000	1500	2500
910	36	0.34	0.45	1500	2500	1200	2000

Undercarriage

Caterpillar designed and built track-type undercarriage.

Track width	(with triple grouser shoes)	Ground Pressure (Average)
standard	450 mm (18") triple grouser	32.4 kPa (4.70 psi)
optional	600 mm (24") triple grouser	24.9 kPa (3.61 psi)
	450 mm (18") segmented rubber track	32.6 kPa (4.73 psi)

308C CR Hydraulic Excavator

Reach Boom Lift Capacities

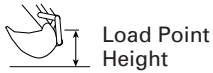

Load Point
Height



Load at
Maximum Reach



Load Radius
Over Front



Load Radius
Over Side

1.67 STICK – 1665 mm (5'6")











BUCKET – 750 mm (30")

UNDERCARRIAGE – Standard

SHOES – 450 mm (18") triple grouser

BOOM – 3700 mm (12'2")

BLADE – Up (or Without Blade)

		1.5 m (5.0 ft)		3.0 m (10.0 ft)		4.5 m (15.0 ft)				m ft
										
6.0 m 20.0 ft	kg lb							*750 *1650	*750 *1650	3.80 11.95
4.5 m 15.0 ft	kg lb			*2050 *4500	*2050 *4500			*600 *1350	*600 *1350	5.32 17.29
3.0 m 10.0 ft	kg lb			*2600 *5600	*2600 *5600	1650 3550	1350 2850	*600 *1300	*600 *1300	5.98 19.58
1.5 m 5.0 ft	kg lb			3100 6600	2400 5200	1600 3400	1300 2700	*650 *1350	*650 *1350	6.13 20.11
Ground Line	kg lb			2900 6250	2250 4850	1550 3250	1200 2600	*750 *1600	*750 *1600	5.82 19.08
-1.5 m -5.0 ft	kg lb	*3900 *8750	*3900 *8750	2900 6200	2250 4800	1500 3250	1200 2550	*1000 *2150	*1000 *2150	4.95 16.16
-3.0 m -10.0 ft	kg lb			*1600 *3150	*1600 *3150			*1300 *2750	*1300 *2750	3.26 10.48

* Limited by hydraulic capacity rather than tipping load. The above loads are in compliance with SAE hydraulic excavator lift capacity rating standard J1097. They do not exceed 87% of hydraulic lifting capacity or 75% of tipping capacity. Weight of all lifting accessories must be deducted from the above lifting capacities.

1.67 STICK – 1665 mm (5'6")











BUCKET – 750 mm (30")

UNDERCARRIAGE – Standard

SHOES – 600 mm (24") triple grouser

BOOM – 3700 mm (12'2")

BLADE – Up (or Without Blade)

		1.5 m (5.0 ft)		3.0 m (10.0 ft)		4.5 m (15.0 ft)				m ft
										
6.0 m 20.0 ft	kg lb							*750 *1650	*750 *1650	3.80 11.95
4.5 m 15.0 ft	kg lb			*2050 *4500	*2050 *4500			*600 *1350	*600 *1350	5.32 17.29
3.0 m 10.0 ft	kg lb			*2600 *5600	*2600 *5600	1700 3650	1400 2950	*600 *1300	*600 *1300	5.98 19.58
1.5 m 5.0 ft	kg lb			3150 6800	2500 5300	1650 3500	1300 2800	*650 *1300	*650 *1350	6.13 20.11
Ground Line	kg lb			3000 6400	2300 4950	1550 3350	1250 2650	*750 *1600	*750 *1600	5.82 19.08
-1.5 m -5.0 ft	kg lb	*3900 *8750	*3900 *8750	3000 6350	2300 4900	1550 3350	1250 2650	*1000 *2150	*1000 *2150	4.95 16.16
-3.0 m -10.0 ft	kg lb			*1600 *3150	*1600 *3150			*1300 *2750	*1300 *2750	3.26 10.48

* Limited by hydraulic capacity rather than tipping load. The above loads are in compliance with SAE hydraulic excavator lift capacity rating standard J1097. They do not exceed 87% of hydraulic lifting capacity or 75% of tipping capacity. Weight of all lifting accessories must be deducted from the above lifting capacities.

308C CR Hydraulic Excavator

Reach Boom Lift Capacities



Load Point Height



Load at Maximum Reach



Load Radius Over Front



Load Radius Over Side

2.21 STICK – 2210 mm (7'3")









BUCKET – 600 mm (24")

UNDERCARRIAGE – Standard

SHOES – 450 mm (18") triple grouser

BOOM – 3700 mm (12'2")

BLADE – Up (or Without Blade)

		1.5 m (5.0 ft)		3.0 m (10.0 ft)		4.5 m (15.0 ft)				m ft
										
6.0 m 20.0 ft	kg lb							*800 *1750	*800 *1750	4.66 14.89
4.5 m 15.0 ft	kg lb					*1650 *3450	1400 3000	*700 *1500	*700 *1500	5.91 19.26
3.0 m 10.0 ft	kg lb			*2200 *4750	*2200 *4750	1700 3600	1350 2900	*650 *1450	*650 *1450	6.50 21.30
1.5 m 5.0 ft	kg lb			*3100 *6650	2500 5300	1600 3400	1300 2750	*700 *1500	650 1450	6.64 21.78
Ground Line	kg lb			2900 6200	2250 4800	1500 3250	1200 2550	*800 *1750	700 1500	6.36 20.85
-1.5 m -5.0 ft	kg lb	*3150 *7100	*3150 *7100	2850 6050	2200 4650	1500 3150	1150 2450	*1000 *2250	850 1850	5.59 18.28
-3.0 m -10.0 ft	kg lb	*3800 *8100	*3800 *8100	*2300 *4900	2250 4800			*850 *1800	*850 *1800	4.01 12.92

* Limited by hydraulic capacity rather than tipping load. The above loads are in compliance with SAE hydraulic excavator lift capacity rating standard J1097. They do not exceed 87% of hydraulic lifting capacity or 75% of tipping capacity. Weight of all lifting accessories must be deducted from the above lifting capacities.

2.21 STICK – 2210 mm (7'3")









BUCKET – 600 mm (24")

UNDERCARRIAGE – Standard

SHOES – 600 mm (24") triple grouser

BOOM – 3700 mm (12'2")

BLADE – Up (or Without Blade)

		1.5 m (5.0 ft)		3.0 m (10.0 ft)		4.5 m (15.0 ft)				m ft
										
6.0 m 20.0 ft	kg lb							*800 *1750	*800 *1750	4.66 14.89
4.5 m 15.0 ft	kg lb					*1650 *3450	1450 3100	*700 *1500	*700 *1500	5.91 19.26
3.0 m 10.0 ft	kg lb			*2200 *4750	*2200 *4750	1750 3700	1400 3000	*650 *1450	*650 *1450	6.50 21.30
1.5 m 5.0 ft	kg lb			*3100 *6650	2550 5450	1650 3500	1300 2800	*700 *1500	700 1500	6.64 21.78
Ground Line	kg lb			3000 6400	2300 4950	1550 3350	1250 2650	*800 *1750	700 1550	6.36 20.85
-1.5 m -5.0 ft	kg lb	*3150 *7100	*3150 *7100	2900 6250	2250 4800	1500 3250	1200 2550	*1000 *2250	900 1900	5.59 18.28
-3.0 m -10.0 ft	kg lb	*3800 *8100	*3800 *8100	*2300 *4900	2300 4900			*850 *1800	*850 *1800	4.01 12.92

* Limited by hydraulic capacity rather than tipping load. The above loads are in compliance with SAE hydraulic excavator lift capacity rating standard J1097. They do not exceed 87% of hydraulic lifting capacity or 75% of tipping capacity. Weight of all lifting accessories must be deducted from the above lifting capacities.

308C CR Hydraulic Excavator

Reach Boom Lift Capacities



Load Point Height



Load at Maximum Reach



Load Radius Over Front



Load Radius Over Side

1.67 STICK – 1665 mm (5'6")









BUCKET – 750 mm (30")

UNDERCARRIAGE – Standard

SHOES – 450 mm (18") triple grouser

BOOM – 3700 mm (12'2")

BLADE – Down

		1.5 m (5.0 ft)		3.0 m (10.0 ft)		4.5 m (15.0 ft)				m ft
										
6.0 m 20.0 ft	kg lb							*750 *1650	*750 *1650	3.80 11.95
4.5 m 15.0 ft	kg lb			*2050 *4500	*2050 *4500			*600 *1350	*600 *1350	5.32 17.29
3.0 m 10.0 ft	kg lb			*2600 *5600	*2600 *5600	*2000 *4350	1550 3300	*600 *1300	*600 *1300	5.98 19.58
1.5 m 5.0 ft	kg lb			*3400 *7300	2800 6000	*2250 *4800	1450 3150	*650 *1350	*650 *1350	6.13 20.11
Ground Line	kg lb			*3600 *7800	2650 5650	*2300 *4950	1400 3000	*750 *1600	*750 *1600	5.82 19.08
-1.5 m -5.0 ft	kg lb	*3900 *8750	*3900 *8750	*3150 *6750	2600 5600	*1900 *4000	1400 3000	*1000 *2150	*1000 *2150	4.95 16.16
-3.0 m -10.0 ft	kg lb			*1600 *3150	*1600 *3150			*1300 *2750	*1300 *2750	3.26 10.48

* Limited by hydraulic capacity rather than tipping load. The above loads are in compliance with SAE hydraulic excavator lift capacity rating standard J1097. They do not exceed 87% of hydraulic lifting capacity or 75% of tipping capacity. Weight of all lifting accessories must be deducted from the above lifting capacities.

1.67 STICK – 1665 mm (5'6")









BUCKET – 750 mm (30")

UNDERCARRIAGE – Standard

SHOES – 600 mm (24") triple grouser

BOOM – 3700 mm (12'2")

BLADE – Down

		1.5 m (5.0 ft)		3.0 m (10.0 ft)		4.5 m (15.0 ft)				m ft
										
6.0 m 20.0 ft	kg lb							*750 *1650	*750 *1650	3.80 11.95
4.5 m 15.0 ft	kg lb			*2050 *4500	*2050 *4500			*600 *1350	*600 *1350	5.32 17.29
3.0 m 10.0 ft	kg lb			*2600 *5600	*2600 *5600	*2000 *4350	1650 3550	*600 *1300	*600 *1300	5.98 19.58
1.5 m 5.0 ft	kg lb			*3400 *7300	3000 6500	*2250 *4800	1600 3400	*650 *1350	*650 *1350	6.13 20.11
Ground Line	kg lb			*3600 *7800	2850 6100	*2300 *4950	1500 3250	*750 *1600	*750 *1600	5.82 19.08
-1.5 m -5.0 ft	kg lb	*3900 *8750	*3900 *8750	*3150 *6750	2850 6050	*1900 *4000	1500 3200	*1000 *2150	*1000 *2150	4.95 16.16
-3.0 m -10.0 ft	kg lb			*1600 *3150	*1600 *3150			*1300 *2750	*1300 *2750	3.26 10.48

* Limited by hydraulic capacity rather than tipping load. The above loads are in compliance with SAE hydraulic excavator lift capacity rating standard J1097. They do not exceed 87% of hydraulic lifting capacity or 75% of tipping capacity. Weight of all lifting accessories must be deducted from the above lifting capacities.

308C CR Hydraulic Excavator

Reach Boom Lift Capacities



Load Point Height



Load at Maximum Reach



Load Radius Over Front



Load Radius Over Side

2.21 STICK – 2210 mm (7'3")









BUCKET – 600 mm (24")

UNDERCARRIAGE – Standard

SHOES – 450 mm (18") triple grouser

BOOM – 3700 mm (12'2")

BLADE – Down

		1.5 m (5.0 ft)		3.0 m (10.0 ft)		4.5 m (15.0 ft)				m ft
										
6.0 m 20.0 ft	kg lb							*800 *1750	*800 *1750	4.66 14.89
4.5 m 15.0 ft	kg lb					*1650 *3450	1600 3450	*700 *1500	*700 *1500	5.91 19.26
3.0 m 10.0 ft	kg lb			*2200 *4750	*2200 *3900	*1800 *3900	1550 3350	*650 *1450	*650 *1450	6.50 21.30
1.5 m 5.0 ft	kg lb			*3100 *6650	2850 6150	*2100 *4500	1500 3150	*700 *1500	*700 *1500	6.64 21.78
Ground Line	kg lb			*3550 *7700	2650 5650	*2300 *4900	1400 2950	*800 *1750	*800 *1750	6.36 20.85
-1.5 m -5.0 ft	kg lb	*3150 *7100	*3150 *7100	*3350 *7200	2550 5500	*2100 *4550	1350 2900	*1000 *2250	1000 2200	5.59 18.28
-3.0 m -10.0 ft	kg lb	*3800 *8100	*3800 *8100	*2300 *4900	*2300 *4900			*850 *1800	*850 *1800	4.01 12.92

* Limited by hydraulic capacity rather than tipping load. The above loads are in compliance with SAE hydraulic excavator lift capacity rating standard J1097. They do not exceed 87% of hydraulic lifting capacity or 75% of tipping capacity. Weight of all lifting accessories must be deducted from the above lifting capacities.

2.21 STICK – 2210 mm (7'3")









BUCKET – 600 mm (24")

UNDERCARRIAGE – Standard

SHOES – 600 mm (24") triple grouser

BOOM – 3700 mm (12'2")

BLADE – Down

		1.5 m (5.0 ft)		3.0 m (10.0 ft)		4.5 m (15.0 ft)				m ft
										
6.0 m 20.0 ft	kg lb							*800 *1750	*800 *1750	4.66 14.89
4.5 m 15.0 ft	kg lb					*1650 *3450	*1650 *3450	*700 *1500	*700 *1500	5.91 19.26
3.0 m 10.0 ft	kg lb			*2200 *4750	*2200 *4750	*1800 *3900	1700 3600	*650 *1450	*650 *1450	6.50 21.30
1.5 m 5.0 ft	kg lb			*3100 *6650	3100 6600	*2100 *4500	1600 3400	*700 *1500	*700 *1500	6.64 21.78
Ground Line	kg lb			*3550 *7700	2850 6100	*2300 *4900	1500 3200	*800 *1750	*800 *1750	6.36 20.85
-1.5 m -5.0 ft	kg lb	*3150 *7100	*3150 *7100	*3350 *7200	2800 5950	*2100 *4550	1450 3150	*1000 *2250	*1000 *2250	5.59 18.28
-3.0 m -10.0 ft	kg lb	*3800 *8100	*3800 *8100	*2300 *4900	*2300 *4900			*850 *1800	*850 *1800	4.01 12.92

* Limited by hydraulic capacity rather than tipping load. The above loads are in compliance with SAE hydraulic excavator lift capacity rating standard J1097. They do not exceed 87% of hydraulic lifting capacity or 75% of tipping capacity. Weight of all lifting accessories must be deducted from the above lifting capacities.

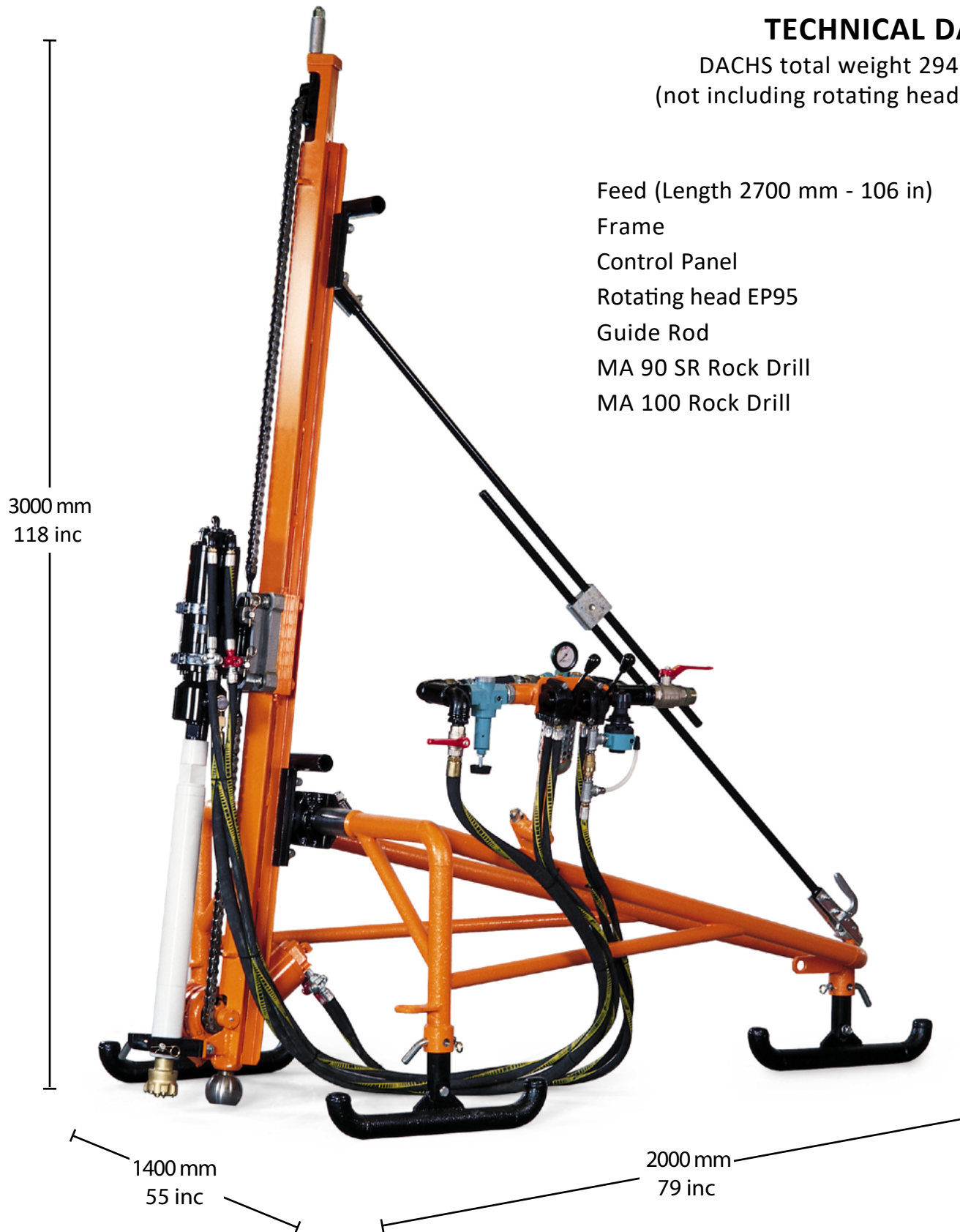

TECHNICAL DATA

DACHS total weight 294 kg (647 lb)
 (not including rotating head and rock drill)

Feed (Length 2700 mm - 106 in)	85 kg (187 lb)
Frame	130 kg (286 lb)
Control Panel	40 kg (88 lb)
Rotating head EP95	36 kg (80 lb)
Guide Rod	10 kg (22 lb)
MA 90 SR Rock Drill	29 kg (64 lb)
MA 100 Rock Drill	58 kg (128 lb)

OVERALL DIMENSIONS

Feed motor air consumption	1000 Lt/min a 6 bar (36 cfm at 87 psi)
Rotating head EP 95 air consumption	2000 Lt/min a 6 bar (73 cfm at 87 psi)
Rock drill air consumption MA90 SR/29 kg	4500 Lt/min a 6 bar (146 cfm at 87 psi)
Rock drill air consumption MA100/58 kg	
- percussion and rotation pneumatic	5700 Lt/min a 5-6 bar (185 cfm at 73-87 psi)
- percussion pneumatic and rotation hydraulic	4500 Lt/min a 6 bar (146 cfm at 73-87 psi)
Oil consumption	approximately 1.5 L every 8 working hours

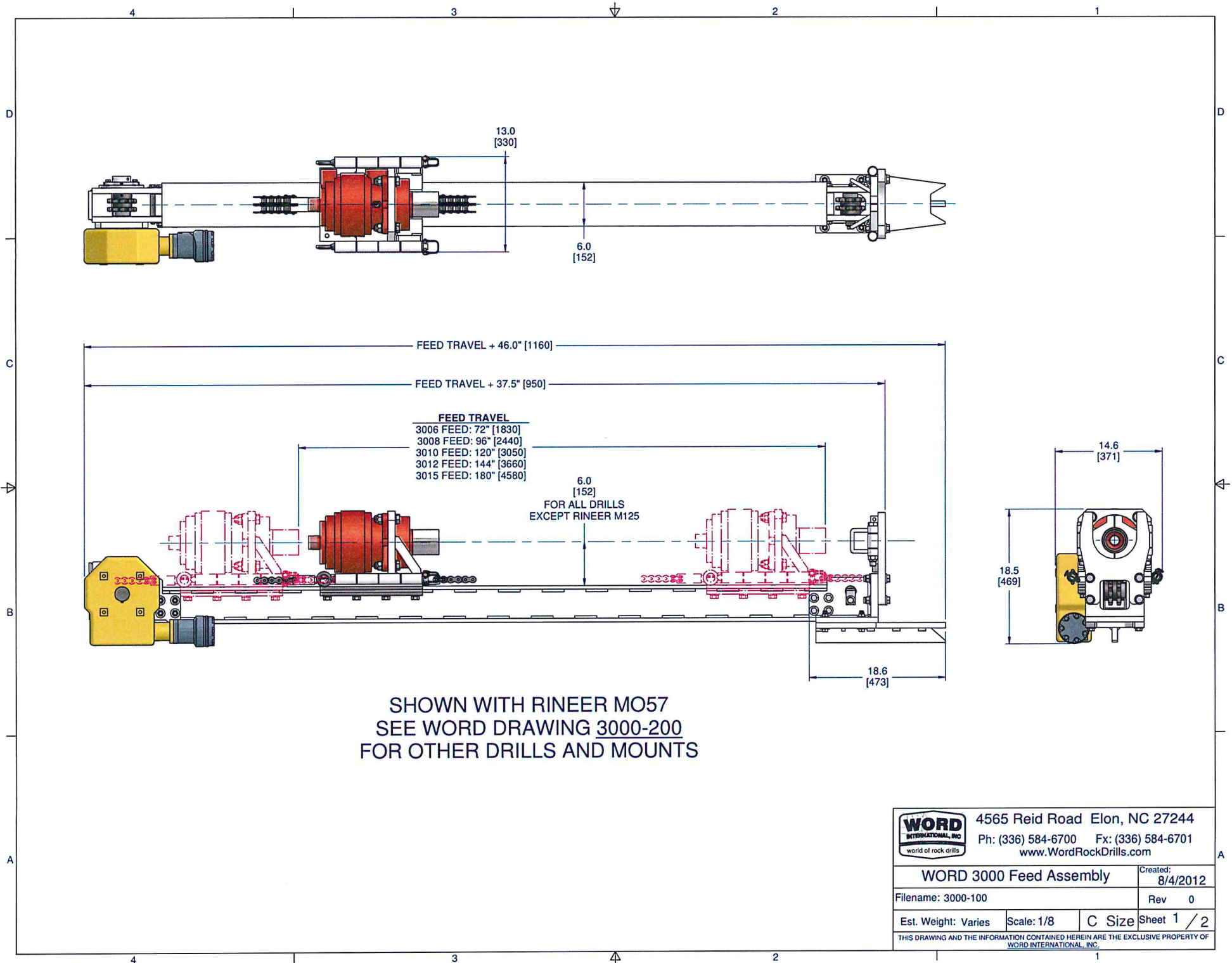

	4565 Reid Road Elon, NC 27244	
	Ph: (336) 584-6700	Fx: (336) 584-6701
		www.WordRockDrills.com
WORD 3000 Feed Assembly		Created: 8/4/2012
Filename: 3000-100		Rev 0
Est. Weight: Varies	Scale: 1/8	C Size Sheet 1 / 2
THIS DRAWING AND THE INFORMATION CONTAINED HEREIN ARE THE EXCLUSIVE PROPERTY OF WORD INTERNATIONAL, INC.		

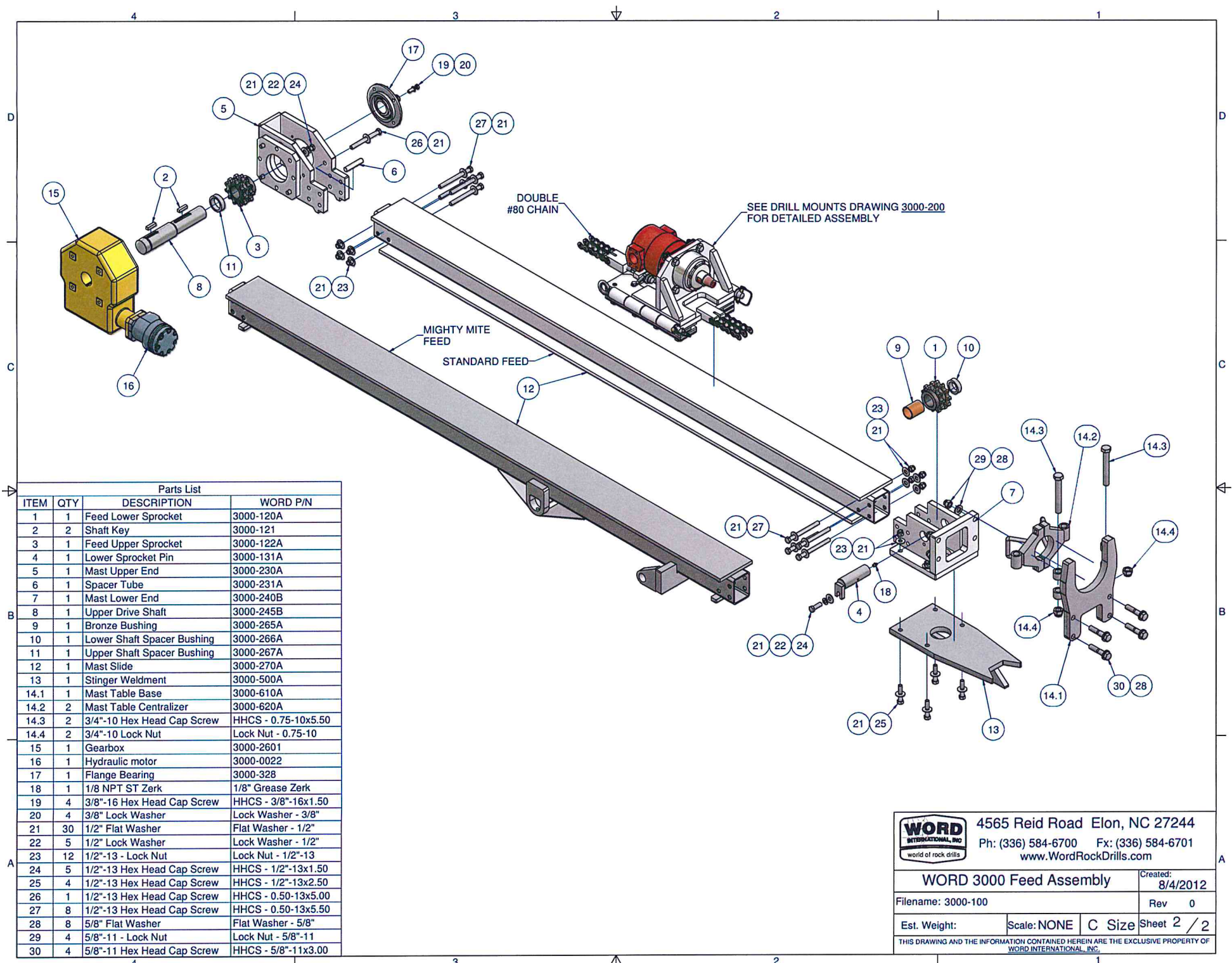

Parts List

ITEM	QTY	DESCRIPTION	WORD P/N
1	1	Feed Lower Sprocket	3000-120A
2	2	Shaft Key	3000-121
3	1	Feed Upper Sprocket	3000-122A
4	1	Lower Sprocket Pin	3000-131A
5	1	Mast Upper End	3000-230A
6	1	Spacer Tube	3000-231A
7	1	Mast Lower End	3000-240B
8	1	Upper Drive Shaft	3000-245B
9	1	Bronze Bushing	3000-265A
10	1	Lower Shaft Spacer Bushing	3000-266A
11	1	Upper Shaft Spacer Bushing	3000-267A
12	1	Mast Slide	3000-270A
13	1	Stinger Weldment	3000-500A
14.1	1	Mast Table Base	3000-610A
14.2	2	Mast Table Centralizer	3000-620A
14.3	2	3/4"-10 Hex Head Cap Screw	HHCS - 0.75-10x5.50
14.4	2	3/4"-10 Lock Nut	Lock Nut - 0.75-10
15	1	Gearbox	3000-2601
16	1	Hydraulic motor	3000-0022
17	1	Flange Bearing	3000-328
18	1	1/8" NPT ST Zerk	1/8" Grease Zerk
19	4	3/8"-16 Hex Head Cap Screw	HHCS - 3/8"-16x1.50
20	4	3/8" Lock Washer	Lock Washer - 3/8"
21	30	1/2" Flat Washer	Flat Washer - 1/2"
22	5	1/2" Lock Washer	Lock Washer - 1/2"
23	12	1/2"-13 - Lock Nut	Lock Nut - 1/2"-13
24	5	1/2"-13 Hex Head Cap Screw	HHCS - 1/2"-13x1.50
25	4	1/2"-13 Hex Head Cap Screw	HHCS - 1/2"-13x2.50
26	1	1/2"-13 Hex Head Cap Screw	HHCS - 0.50-13x5.00
27	8	1/2"-13 Hex Head Cap Screw	HHCS - 0.50-13x5.50
28	8	5/8" Flat Washer	Flat Washer - 5/8"
29	4	5/8"-11 - Lock Nut	Lock Nut - 5/8"-11
30	4	5/8"-11 Hex Head Cap Screw	HHCS - 5/8"-11x3.00

	4565 Reid Road Elon, NC 27244		Created: 8/4/2012
	Ph: (336) 584-6700 Fx: (336) 584-6701		
WORD 3000 Feed Assembly			Sheet 2 / 2
Filename: 3000-100	Scale: NONE	C Size	
THIS DRAWING AND THE INFORMATION CONTAINED HEREIN ARE THE EXCLUSIVE PROPERTY OF WORD INTERNATIONAL, INC.			



DK30-1

DK-A30 -I HAMMER

- ✓ ***IR3.5/XL3 SHANK DESIGN***
- ✓ ***NEW GENERATION***
- ✓ ***SUPERIOR TECHNOLOGY***
- ✓ ***STANDARD BIT DIAMETERS, 3.5" – 4"***
- ✓ ***DELIVERS MORE ENERGY PER BLOW***
- ✓ ***HARDENED PISTON FOR EXTENDED LIFE***
- ✓ ***INNOVATIVE DESIGN FOR MAXIMUM PERFORMANCE WITH MINIMUM MAINTENANCE***

DRILL KING INTERNATIONAL
820 Sixth Avenue ♦ Mansfield, TX 76063 ♦ USA
Main#: 817-539-2500 ♦ Fax#: 682-222-1050
Sales #: 817-539-2501 ♦ Toll Free#: 866-900-2487
sales@drillking.net ♦ www.drillking.net

The newest generation of Drill King Hammers means faster penetration, longer life, and less down time due to down hole failures.

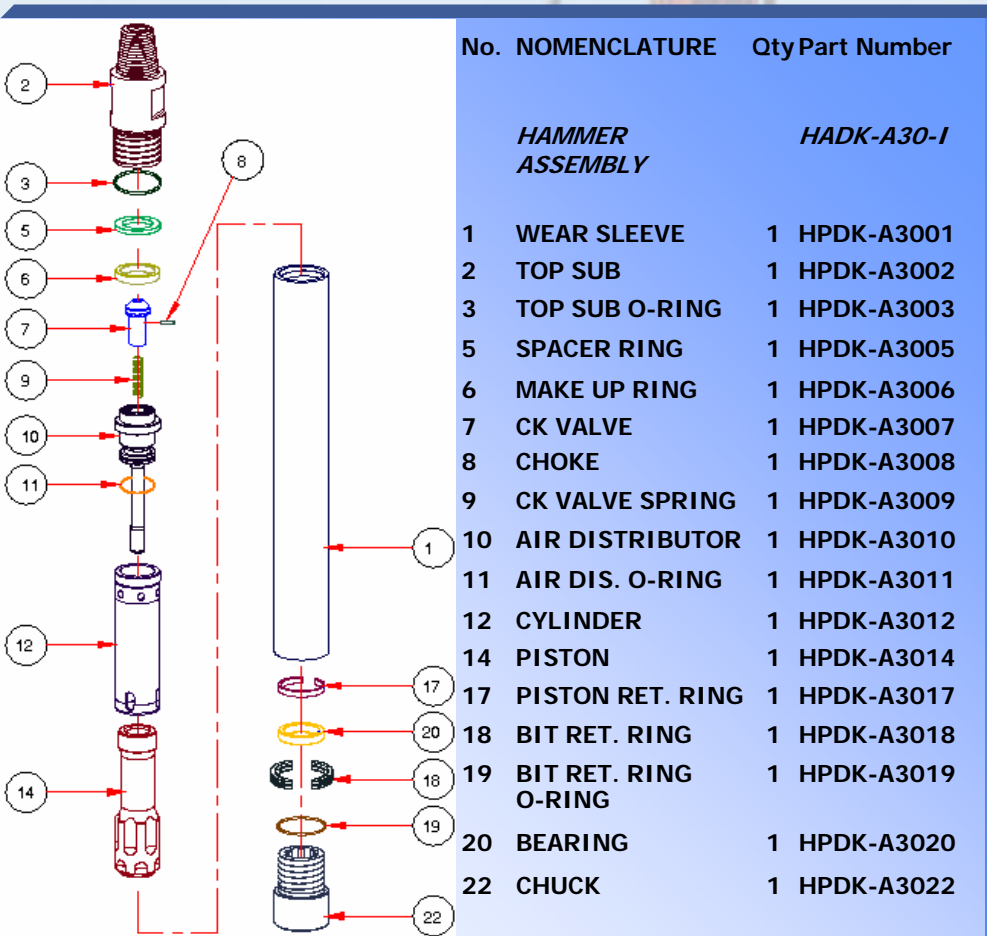

Drilling Parameters	
Working Pressure	150-350
Application Bit	3.5" – 4"
Feed Force (lbs.)	500-1,900

Air Consumption at Different Working Pressures	
150 psi (scfm)	215
200 psi (scfm)	275
250 psi (scfm)	350
350 psi (scfm)	480

Dimensions & Weights	
TOP SUB : 2.38" API PIN	
Tool Length (in)	34.25
Outside Dia. (in)	3.35
Piston Diameter (in)	2.40
Stroke (in)	3.00
Weight w/o Bit (lbs)	53
Piston Weight (lbs)	8.4

Nothing contained in this brochure is intended to extend any warranty or representation for applications expressed or implied, regarding the products described herein. Any such warranties or other terms and conditions of sale of products shall be in accordance with Drill King's standard terms and conditions of sale for such products, which are available upon request.



Portable Air Power

185 CFM PORTABLE

Equipped with the world-renowned Sullair Air-End

185 cfm at 100 psig • 5.2 m³/min at 7 bar

Why Sullair?

Air Compressors built to last

Since 1965, Sullair has been recognised worldwide as an innovator and leader in rotary screw compression and vacuum technology. Our durable air compressors feature the legendary Sullair bulletproof air end, precision-engineered for maximum performance with leading-edge rotary screw technology.

The award-winning air end design sets the industry standard and delivers the quality and reliability you expect from a leader. And as a premium provider of compressed air solutions, we take great pride in the production of systems that will provide a steady source of air tomorrow – just as they do today.

The Complete Compressed Air Solution

Count on Sullair for quality portable solutions to help with any application, at any job site. As your trusted compressed air partner, Sullair offers a full lineup of portable air compressors, from 185 to 1600 cfm in a pressure range from 100 psi to 500 psi.

Aftermarket Products and Support

AWF®

Keep your compressor running clean and cool with genuine AWF, a 1,500-hour, all-weather lubricant that helps maintain the machine's 5-year warranty. Designed to maximize air/fluid separation and limit fluid carryover, this lubricant helps protect against rust and corrosion – extending the life of your compressor and keeping it operating at peak performance.

Construction Air Tools

Sullair's construction tools are the perfect partners to our range of Portable Air Compressors. We have a full inventory of quality air tools, engineered to work seamlessly with your portable compressor, and designed for a variety of applications. Choose from our wide range of paving breakers, chipping hammers, rock drills, clay diggers, tampers and rivet busters.

Genuine Parts and Service

At Sullair, our design and engineering teams ensure that the parts used in our compressors are of the highest quality, providing years of trouble-free performance. That is why when it comes to replacement parts, it is essential to only use Genuine Sullair replacement parts.

THE NEXT GENERATION OF PORTABLE PERFORMANCE

The workhorse of our elite mobile fleet, the Sullair 185A is reimagined for the future to deliver value to our customers. We listened to your wants and needs and incorporated valued customer feedback into our design. As a direct result of your input, our new and improved product is fully optimised and ready to hit the road.

FEATURES

- Fully Bundled Design to contain 126% total fluid volume
- Dedicated After cooler with moisture separator
- Fuel and temperature gauges
- Serviceable components are within easy reach, routine maintenance is simplified
- Australian ALKO designed and supplied running gear
- Simple servicing
- No gear box
- Triple pass air filter design with twin elements
- Robust and efficient Sullair 14 series air end
- Efficient package design with low fuel consumption
- Lockable battery isolator

ENVIRONMENTAL FEATURES

- 400 hour engine oil change
- 1500 hour compressor lube change
- Powered by a fuel efficient 60HP Kubota Turbo diesel engine
- Efficient package design with very low diesel consumption
- Dedicated aftercooler with integrated moisture separator and auto drain to remove water from compressed air

SAFETY FEATURES

- Hinged, padlockable cover
- Guarding for all moving parts
- Heat cladding insulation for all hot exhaust surfaces
- Padlockable isolator
- E Stop

CLAM SHELL CANOPY

- Canopy opens with gas assist Struts
- Serviceable components are within easy reach, routine maintenance time is significantly reduced (60%)
- Powder coated steel canopy can be color coded to meet customer needs and easy to apply customer dedicated artwork

HIGHWAY TOWABLE RUNNING GEAR

- ALKO Australian designed and supplied running gear
- T -chassis design with hydraulic brakes and robust jockey wheel
- Transport security chains
- Plastic mudguards reduces visible scratches and dents

TWO-STAGE DRY TYPE AIR FILTERS

- Separate filters for engine and compressor
- Dual elements with dust indicators

CONTROLS

- Pneumatic inlet valve and unloaded starting
- No proprietary PLC logic
- Simple electromechanical design - designed for ease of diagnosis
- Automotive style fuses and relays
- Warm up and turbo cool down timers

AIR END WARRANTY

- 2-year standard warranty
- 5-year or 10,000-hour warranty when continuously serviced at the recommended intervals with Sullair AWF Compressor Fluid and filters

TECHNICAL SPECIFICATIONS

GENERAL	
Model	185A
Actual Delivery - cfm (m ³ / min)	185 (5.2)
Rated Pressure - psig (bar)	100 (7)
Pressure Range, min - psig (bar)	80 (5.5)
Pressure Range, max - psig (bar)	125 (8.6)
Shaft Power - kW (BHP)	32 (43)
Maximum working angle	15°
Operating temperature range °C	0 - 50

ENGINE	
Make & Model	V2403-M-DI-TE2B
Operating Speed - rpm	2700
Available Power - bhp (kW)	62.5 (46)
Displacement - Litres	2.43
Cooling System Capacity - Litres	10
Engine Oil Capacity - Litres	10
Fuel Tank Capacity - Litres	75
Electrical System Voltage	12
Battery Rating - CCA	750

COMPRESSOR	
Service Valves - No. (Size)	2 (3/4" NPT)
Compressor Oil Capacity - Litres	18
Sound Noise level @ 7m dB(A)	76

DPQ PACKAGE	
Working Weight - kg	1090
Tare Weight - kg	1040
Length - mm	3315
Width - mm	1600
Height - mm	1495
Axle Rating - kg	1450
Tyre Size	165R13LT

DLQ PACKAGE	
Working Weight - kg	918
Tare Weight - kg	868
Length - mm	2076
Width - mm	1159
Height - mm	1183

PERFORMANCE	
Fuel Consumption 100% Load -l/h	10.4
Fuel Consumption 75% Load -l/h	7.7
Fuel Consumption 50% Load -l/h	6.7
Fuel Consumption 25% Load -l/h	6
Max. Operating Altitude - m	3000

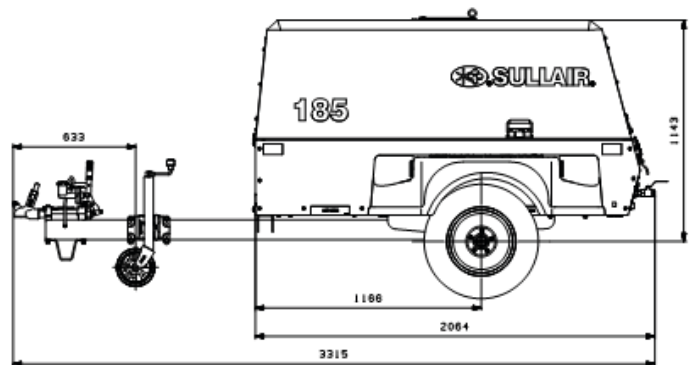
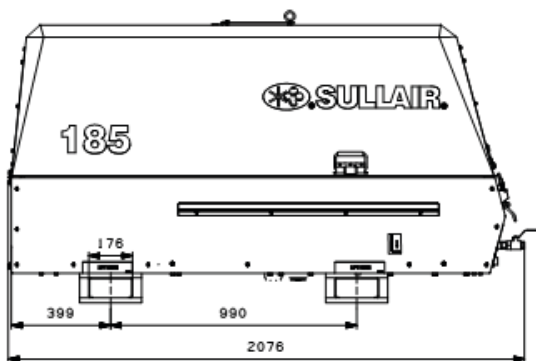

Contact your Sullair Representative Today!



www.sullair.com.au | 1300 266 773

© Copyright 2016 Sullair Corporation. All rights reserved. The color green is a registered trademark of Sullair Corporation. Specifications subject to change without notice.



Atlas Copco Portable Air Compressors

Most diverse product line



Atlas Copco is the leading innovator worldwide in the portable compressor industry. When designing our units our goal is to build the strongest, most fuel efficient, and longest lasting compressors on the market. You will find that we have created a compressor for virtually any application - from running small hand tools in the construction industry to drilling offshore in the oil and gas business. Atlas Copco is the global front runner in providing the lightest and smallest product line as footprint and weight are becoming an increasingly common concern in today's industry.

Health, Safety and Environment

Atlas Copco's stringent manufacturing standards follow ISO 9001 quality assurance regulations. All components are produced and tested to exacting standards for optimum performance in the most demanding conditions.

Atlas Copco



Full Line

Model Number	XAS 70 KD7	XAS 90 KD7	XAHS 70 DD7	XAS 90 DD7
FAD Rating	71 cfm/102 psi	88 cfm/102psi	67 cfm/175psi	92 cfm/102psi
Min./ Max. Working Pressure	58/128	58/128	58/196	58/128
Engine	Kubota D905	Kubota D1105	Deutz D2011L02	Deutz D2011L02
Engine Control	Mechanical	Mechanical	Mechanical	Mechanical
Aspiration	Natural	Natural	Natural	Natural
Horsepower	25	26	29	29
Number of Cylinders	3	3	2	2
Cooling System	Water	Water	Oil	Oil
Full Load Speed	3600	3000	2400	2400
Fuel Tank Capacity (Gal.)	8.46	8.46	10.57	10.57
Fuel Consumption @ 0% load (Gal/hr) ¹	.07	.07	0.8	0.8
Fuel Consumption @ 100% load (Gal/hr) ¹	1.5	1.5	1.4	1.4
¹ without FuelXpert™				
Compression Stages	1	1	1	1
Outlet Valve Configuration	2 X 3/4"	2 X 3/4"	2 X 3/4"	2 X 3/4"
Compressor Cooling System	Air/Oil	Air/Oil	Air/Oil	Air/Oil
Compressor Oil Capacity (Gal.)	1.45	1.45	2.1	2.1
Air Receiver Capacity (Gal.)	2.47	2.47	3.14	3.14
Sound Pressure Level @ 23 Ft.	70 dBa	70 dBa	70 dBa	70 dBa
Dimensions LxWxH (wheel mtd.)	101 x 51 x 45	101 x 51 x 45	108 x 52 x 49	108 x 52 x 49
Wheel Mtd Wet Weight (Lbs.) ²	1,213	1,213	1,588	1,588
Dimensions LxWxH (skid mtd.)	62 x 40 x 34	62 x 40 x 34	74 x 38 x 48	74 x 38 x 48
Skid Mtd Wet Weight (Lbs.) ²	1,047	1,047	1,510	1,510

²Please ask sales representative for all undercarriage configurations.

Full Line

Model Number	XAS 375 JD6	XATS 375 JD6	XAS 300 DD7	XAHS 375 DD6	XAHS 250 DD7	XAHS 300 DD7
FAD Rating	375 cfm/100psi	375 cfm/150psi	265 cfm/102psi	371 cfm/175psi	197 cfm/175psi	392 cfm/175psi
Min./ Max. Working Pressure	58/125	58/175	58/123	58/196	58/196	58/196
Engine	Deere 4045HF285	Deere 4045HF285	Deutz TD 2011	Deutz TCD2012L04	Deutz TD 2011	Deutz TD 2011
Engine Control	Electronic	Electronic	Mechanical	Mechanical	Mechanical	Mechanical
Aspiration	Turbocharged	Turbocharged	Turbocharged	Turbocharged	Turbocharged	Turbocharged
Horsepower	115	125	70	139	70	111
Number of Cylinders	4	4	4	4	4	4
Cooling System	Water	Water	Oil	Water	Oil	Water
Full Load Speed	2400	2400	2400	2200	2400	2300
Fuel Tank Capacity (Gal.)	38	38	34	46	34	46
Fuel Consumption @ 0% load (Gal/hr) ¹	1.46	1.46	1.6	N.A.	1.6	N.A.
Fuel Consumption @ 100% load (Gal/hr) ¹	5.34	5.8	3.8	6.9	3.8	5.9
¹ without FuelXpert™						
Compression Stages	1	1	1	1	1	1
Outlet Valve Configuration	1 x 1.5" / 2 x 3/4"	1 x 1.5" / 2 x 3/4"	3 x 3/4"	1 x 1.5" / 2 x 3/4"	3 x 3/4"	1 x 1.5"
Compressor Cooling System	Air/Oil	Air/Oil	Air/Oil	Air/Oil	Air/Oil	Air/Oil
Compressor Oil Capacity (Gal.)	8	8	3.4	6.2	3.04	6.2
Air Receiver Capacity (Gal.)	11.1	11.1	9.3	11.1	9.3	11.1
Sound Pressure Level @ 23 Ft.	76 dBa	76 dBa	71 dBa	71 dBa	71 dBa	71 dBa
Dimensions LxWxH (wheel mtd.)	145 x 72 x 71	145 x 72 x 71	175 x 67 x 59	155 x 67 x 65	175 x 67 x 59	155 x 67 x 65
Wheel Mtd Wet Weight (Lbs.) ²	3,860	3,860	2,150	3,969	2,150	3,969
Dimensions LxWxH (skid mtd.)	104 x 55 x 68	104 x 55 x 68	93 x 44 x 53	109 x 67 x 45.7	100 x 44 x 53	109 x 67 x 45.7
Skid Mtd Wet Weight (Lbs.) ²	3,920	3,920	1,985	3,769	1,985	3,769

²Please ask sales representative for all undercarriage configurations.

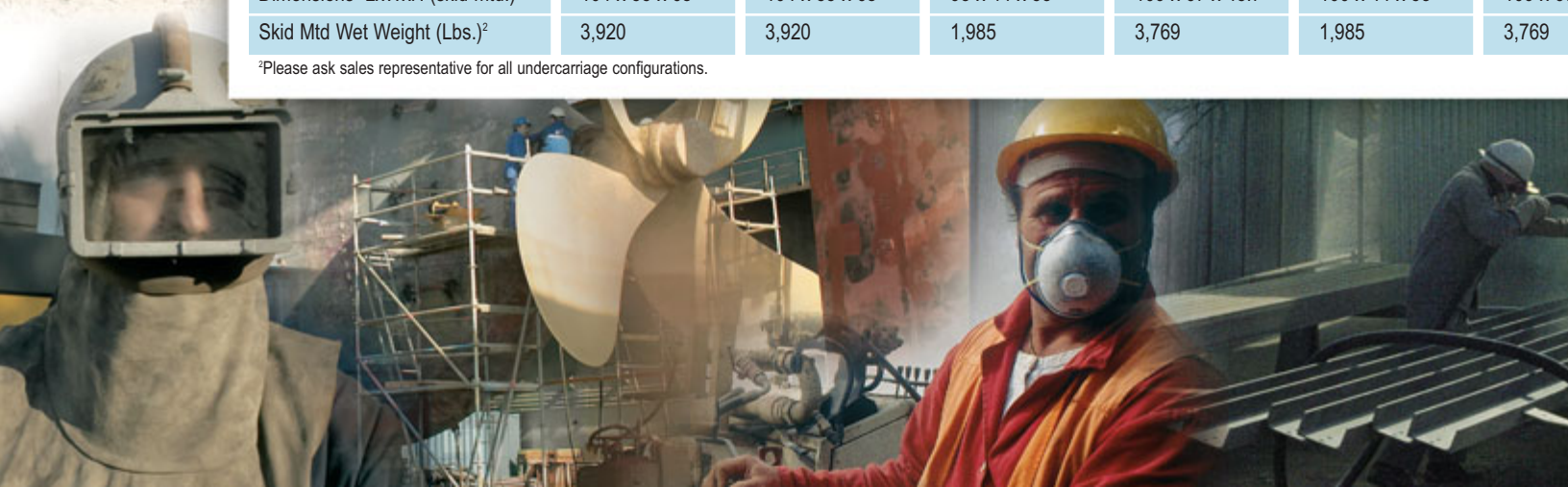



XAMS DD6	XATS 350 DD6	XAS 375 DD6	XAS 750 CD6	XAMS 600 CD6	XAHS 500 CD6	XAMS 850 CD7	XAMS 1050 CD6	XAMS 1150 CD6
175psi	341 cfm/150psi	392 cfm/102psi	750 cfm/100psi	610 cfm/125psi	507 cfm/175psi	848 cfm/125psi	1059 cfm/125psi	1127 cfm/125psi
	58/171	58/123	58/125	58/145	58/195	58/150	58/145	58/145
CD2012L04	Deutz TCD2012L04	Deutz TCD2012L04	CAT 6.6 ACERT III	CAT 6.6 ACERT III	CAT 6.6 ACERT III	CAT 7 ACERT III	CAT C-9 ACERT III	CAT C-13 ACERT III
ical	Mechanical	Mechanical	Electronic	Electronic	Electronic	Electronic	Electronic	Electronic
arged	Turbocharged	Turbocharged	Turbocharged	Turbocharged	Turbocharged	Turbocharged	Turbocharged	Turbocharged
	111	111	200	173	173	249	300	426
	4	4	6	6	6	6	6	6
	Water	Water	Water	Water	Water	Water	Water	Water
	2300	2300	2100	1900	1900	2000	1800	1600
	46	46	76	77	77	77.4 + 26.4	142	142
	N.A.	N.A.	3.8	4.3	4.5	6.8	8.3	8.9
	5.9	5.7	10	8.5	8.9	13.4	15.6	17.1
	1	2	1	1	1	1	1	1
2 x 3/4"	1 x 1.5" / 3 x 3/4"	1 x 1.5" / 4 x 3/4"	1 x 1.5" / 2 x 3/4"	1 x 1.5" / 2 x 3/4"	1 x 1.5" / 2 x 3/4"	1 x 2" / 2 x 3/4"	1 x 2.5"	1 x 2.5"
	Air/Oil	Air/Oil	Air/Oil	Air/Oil	Air/Oil	Air/Oil	Air/Oil	Air/Oil
	6.2	6.2	12	13.7	13.7	13.7	21	21
	11.1	11.1	16.78	16.78	16.78	16.78	43.3	43.3
	71 dBa	71 dBa	76 dBa	71 dBa	71 dBa	72 dBa	72 dBa	72 dBa
7 x 65	155 x 67 x 45.7	155 x 67 x 45.7	203 x 78 x 78	203 x 78 x 78	203 x 78 x 78	199 x 78 x 82	222 x 84 x 98	222 x 84 x 98
	3,969	3,969	6,405	6,612	6,612	7,497	13,973	14,600
7 x 45.7	109 x 67 x 45.7	109 x 67 x 45.7	132 x 62 x 72	132 x 62 x 72	132 x 62 x 72	132 x 62 x 78	159 x 84 x 95	159 x 84 x 95
	3,769	3,769	5,835	5,918	5,918	7,189	12,543	14,080





XATS 800 CD7	XATS 950 CD6	XAHS 710 CD7	XAHS 900 CD6	XAHS 1150 CD6	XAVS 650 CD7	XAVS 830 CD6	XRS 830 CD6	XRS 1150 CD6
774 cfm/150psi	949cfm/150psi	719 cfm/175psi	885 cfm/175psi	1103 cfm/175psi	657 cfm/204psi	805 cfm/203psi	830 cfm/250psi	784 cfm/250psi
58/171	58/174	58/195	58/195	58/195	58/224	58/219	58/272	174/315
CAT 7 ACERT III	CAT C-9 ACERT III	CAT 7 ACERT III	CAT C-9 ACERT III	CAT C-13 ACERT III	CAT 7 ACERT III	CAT C-9 ACERT III	CAT C-9 ACERT III	CAT C-9 ACERT III
Electronic	Electronic	Electronic	Electronic	Electronic	Electronic	Electronic	Electronic	Electronic
Turbocharged	Turbocharged	Turbocharged	Turbocharged	Turbocharged	Turbocharged	Turbocharged	Turbocharged	Turbocharged
249	300	249	300	426	249	300	300	300
6	6	6	6	6	6	6	6	6
Water	Water	Water	Water	Water	Water	Water	Water	Water
2000	1800	2000	1800	1600	2000	1800	1800	1800
77.4 + 26.4	142	77.4 + 26.4	142	210	77.4 + 26.4	142	142	142
6.8	8.1	6.2	8.1	10.5	6.4	8	6.7	6.9
13.6	15.2	13.1	15.6	20	13.3	15.6	11.9	15.3
1	1	1	1	1	1	1	2	2
1 x 2" / 2 x 3/4"	1 x 2.5"	1 x 2" / 2 x 3/4"	1 x 2.5 "	1 x 2.5 "	1 x 2" / 2 x 3/4"	1 x 2.5 "	1 x 2 "	1 x 2 "
Air/Oil	Air/Oil	Air/Oil	Air/Oil	Air/Oil	Air/Oil	Air/Oil	Air/Oil	Air/Oil
13.7	23.8	13.7	16	21	13.7	16	19.8	19.8
16.78	43.3	16.78	24	43.3	16.78	24	37.8	37.8
72 dBa	72 dBa	72 dBa	72 dBa	72 dBa	72 dBa	72 dBa	72 dBa	72 dBa
199 x 78 x 82	222 x 84 x 98	199 x 78 x 82	222 x 84 x 98	220 x 82 x 96	199 x 78 x 82	222 x 84 x 98	222 x 84 x 98	222 x 84 x 98
7,497	12,954	7,497	12,734	14,660	7,497	12,734	13,820	13,820
132 x 62 x 78	159 x 84 x 95	132 x 62 x 78	159 x 84 x 95	159 x 84 x 95	132 x 62 x 78	159 x 84 x 95	159 x 84 x 95	159 x 84 x 95
7,189	12,320	7,189	12,120	12,910	7,189	11,740	12,050	12,050





000 CD6	XRHS 1100 CD6	XRVS 700 CD6	XRVS 1000 CD6	XAS 1600 CD6	XAS 1600 CD6	XAS 1600 CD6	XRXS 1200 CD6
h/290psi	1059 cfm/290psi	695 cfm/365psi	974 cfm/365psi	1600 cfm/100psi	1500 cfm/125psi	1400 cfm/150psi	1200cfm/435psi
9	174/319	225/392	225/392	58/125	58/140	58/165	275/465
ACERT III	CAT C-13 ACERT III	CAT C-9 ACERT III	CAT C-13 ACERT III	CAT C-13 ACERT III	CAT C-13 ACERT III	CAT C-13 ACERT III	CAT C-18 ACERT III
Electronic	Electronic	Electronic	Electronic	Electronic	Electronic	Electronic	Electronic
Turbocharged	Turbocharged	Turbocharged	Turbocharged	Turbocharged	Turbocharged	Turbocharged	Turbocharged
426	300	426	440	440	440	575	
6	6	6	6	6	6	6	
Water	Water	Water	Water	Water	Water	Water	Water
1600	1800	1600	1900	1800	1650	1800	
142	142	142	142	142	142	258	
9.8	7.3	10.3	9.3	10.3	11.3	12.6	
21.1	15.3	21.1	21.3	21.6	21.1	30	
2	2	2	1	1	1	2	
1 x 2 "	1 x 2 "	1 x 2 "	1 x 3 "	1 x 3 "	1 x 3 "	1 x 2 "	
Air/Oil	Air/Oil	Air/Oil	Air/Oil	Air/Oil	Air/Oil	Air/Oil	
19.8	19.8	19.8	22.46	22.46	22.46	21.7	
37.8	37.8	37.8	45.18	45.18	45.18	37.8	
72 dBa	72 dBa	72 dBa	76 dBa	76 dBa	76 dBa	76 dBa	
222 x 84 x 98	222 x 84 x 98	222 x 84 x 98	222 x 84 x 98	222 x 84 x 98	222 x 84 x 98	260 x 89 x 98.8	
14,660	13,820	14,660	15,420	15,420	15,420	18,080	
159 x 84 x 95	159 x 84 x 95	159 x 84 x 95	159 x 84 x 95	159 x 84 x 95	159 x 84 x 95	180 x 89 x 95.9	
13,250	12,050	13,250	13,219	13,219	13,219	16,700	





XAS 110 DD7	XATS 125 DD7	XAS 130 DD7	XAS 150 DD7	XAS 185 JD7	XAS 185 JD7 PE	XAS 185 JDU6
106 cfm/102psi	125 cfm/150psi	130 cfm/102psi	152 cfm/102psi	185 cfm/100psi	185 cfm/100psi	185 cfm/100psi
58/128	58/171	58/128	58/128	58/125	58/125	58/125
Deutz 2011L02	Deutz D2011L03	Deutz D2011L03	Deutz D2011L03	Deere 4024T	Deere 4024T	Deere 4045D
Mechanical	Mechanical	Mechanical	Mechanical	Mechanical	Mechanical	Mechanical
Natural	Natural	Natural	Natural	Turbocharged	Turbocharged	Natural
31	48	44	42	49	49	80
2	3	3	3	4	4	4
Oil	Oil	Oil	Oil	Water	Water	Water
2750	2750	2400	2300	2750	2750	2100
10.57	21.13	21.13	21.13	25	25	31
0.8	1.1	1	1.2	1	1	0.9
1.7	2.3	1.9	1.9	2.9	2.9	2.6
1	1	1	1	1	1	1
2 X 3/4"	2 X 3/4"	2 X 3/4"	2 X 3/4"	2 X 3/4"	2 X 3/4"	2 X 3/4"
Air/Oil	Air/Oil	Air/Oil	Air/Oil	Air/Oil	Air/Oil	Air/Oil
2.1	2.1	2.1	2.1	2	2	2.5
3.14	3.14	3.14	3.14	3.8	3.8	3.14
70 dBa	70 dBa	70 dBa	70 dBa	76 dBa	76 dBa	76 dBa
108 x 52 x 49	111 x 55 x 49	111 x 55 x 49	111 x 55 x 49	125 x 60 x 57	127 x 64 x 61	n/a
1,588	1,940	1,940	1,963	2,400	2,330	n/a
74 x 38 x 48	79 x 41 x 48	79 x 41 x 48	79 x 41 x 48	77 x 41 x 54	81 x 45 x 65	85 x 34 x 55
1,510	1,852	1,852	1,873	2,200	2,130	2,400





Full Line

Model Number	XRVS 1250 CD6	XAH 2250 CD6 S	XAH 2250 CD6 O	XRV 2000 CD6 S	XRV 2000 CD6 O
FAD Rating	1273cfm/365psi	2232cfm/175psi	2232cfm/175psi	1975cfm/365psi	1975cfm/365psi
Min./ Max. Working Pressure	232/390	58/195	58/195	186/383	186/383
Engine	CAT C-18 ACERT III	2 CAT C13 ACERT III	2 CAT C13 ACERT III	2 CAT C13 ACERT III	2 CAT C13 ACERT III
Engine Control	Electronic	Electronic	Electronic	Electronic	Electronic
Aspiration	Turbocharged	Turbocharged	Turbocharged	Turbocharged	Turbocharged
Horsepower	575	2 x 440	2 x 440	2 x 440	2 x 440
Number of Cylinders	6	2 x 6	2 x 6	2 x 6	2 x 6
Cooling System	Water	Water	Water	Water	Water
Full Load Speed	1800	1600	1600	1600	1600
Fuel Tank Capacity (Gal.)	258	476	476	476	476
Fuel Consumption @ 0% load (Gal/hr) ¹	11.4	21	21	20.6	20.6
Fuel Consumption @ 100% load (Gal/hr) ¹	26.5	40	40	42.2	39.7
¹ without FuelXpert™					
Compression Stages	2	2 x 1	2 x 1	2 x 2	2 x 2
Outlet Valve Configuration	1 x 2 "	2 x 3 "	2 x 3 "	2 x 3 "	2 x 3 "
Compressor Cooling System	Air/Oil	Air/Oil	Air/Oil	Air/Oil	Air/Oil
Compressor Oil Capacity (Gal.)	21.7	42	42	39.6	39.6
Air Receiver Capacity (Gal.)	37.8	86.6	86.6	75.6	75.6
Sound Pressure Level @ 23 Ft.	76 dBa	83 dBa	83 dBa	83 dBa	83 dBa
Dimensions LxWxH (wheel mtd.)	260 x 89 x 98.8	N.A.	N.A.	N.A.	N.A.
Wheel Mtd Wet Weight (Lbs.) ²	18,080	N.A.	N.A.	N.A.	N.A.
Dimensions LxWxH (skid mtd.)	180 x 89 x 95.9	20' X 8' X 8.5'	20' X 8' X 8.5'	20' X 8' X 8.5'	20' X 8' X 8.5'
Skid Mtd Wet Weight (Lbs.) ²	16,700	31,973	31,973	33,075	33,075

²Please ask sales representative for all undercarriage configurations.



Use only authorized parts. Warranty or Product Liability does not cover any damage or malfunction caused by the use of unauthorized parts.

The information contained herein is general in nature and is not intended for specific construction, installation or application purposes.

Copyright © 2008 Atlas Copco Compressors LLC.
 All rights reserved.

® Atlas Copco is a registered trademark of Atlas Copco AB

ChemGrout® CG-500 Versatile Series

The CG-500 Series are balanced systems that enable high volume production and continuous mixing for a broad range of applications.

CG500/2C6/A
Air Powered



Specially designed mix tank provides high shearing action for thorough and complete particle wetting, producing superior grout.

For grouting tunnels, shafts, dams, mines, void filling, tiebacks, piling encasements, rock grouting & wells.

Mixes & pumps neat cement or cement/sand grouts. Mixing & pumping all on one skid for fast mobilization.

Maximum output 20 gpm (76 lpm). Maximum pressure 174 psi (12 Bar), optional 261 psi (18 Bar).

Two 70 gallon (265 liter) mixing tanks & a 15 gallon (57 liter) holding hopper allows continuous production.

Power options include air, hydraulic, electric/hydraulic gas/hydraulic & diesel/hydraulic.

ChemGrout®
Widest Selection of Grouting Equipment in the World

Versatile Series – High Output, Continuous Operation

Highly versatile, the CG-500 handles a broad range of grouting applications including tunnels, shafts, dams, plant maintenance and geotechnical works. The unique twin mix tank design permits continuous pumping as each tank alternates feeding the hopper. This non-stop pumping process maximizes the batching of materials such as neat cement, sand/cement, and most commercial pre-bagged grouts.

Two high-capacity 70-gallon mixing tanks, pump, and 15-gallon holding hopper are all mounted on a single skid for quick, easy set-up and immediate operation. The holding hopper includes an internal auger that keeps the material thoroughly mixed while supplying the pump.

The open throat grout pump features a non-pulsating positive displacement rotor-stator that provides a constant discharge of materials. This progressing cavity pump is variable speed with an output of up to 20 gpm with a standard maximum pressure of 174 psi (261 psi optional).



CG-500GH
Gas/Hydraulic

Specifications

CG500 Pump	2C6	3C6
Pump	open throat, non pulsating	
Maximum Output	20 gpm (76 lpm)	
Maximum Pressure	174 psi (12 Bar)	261 psi (18 Bar)

CG500 Power	Required	Weight	Size
Air	250 cfm, 100 psi	1100 lbs	88L X 34W X 58H
Hydraulic	12 gpm, 1200 psi	1050 lbs	88L X 34W X 58H
Electric/Hydraulic	*3 Phase only	1550 lbs	88L X 34W X 58H
Gas/Hydraulic	Self contained	1425 lbs	88L X 34W X 58H
Diesel/Hydraulic	Self contained	1625 lbs	100L X 34WX 58H

* Several voltages available

Industries

Tunneling	Well Drilling	Geotechnical
Construction	Mining	Municipal
Restoration	Highway	



New high-strength aluminum alloy progressing cavity pump with quick access cleanout port.

Accessories

Grout Hose. Equipped with quick disconnect fittings. Available in 25 and 50 foot lengths.



Water Meters. Available in manual or automatic. Accurately measures the water for each batch.



Diaphragm Protected Pressure Gauge.



Mechanical Surface Packer. Equipped with shut-off valve and a quick disconnect fitting.

Applications include:

Soil compaction, rock grouting, void-filling, waterproofing, soil anchors, cable bolts, rock bolts, well encasements, contact grouting, well abandonment, marine/underwater, post tensioning, precast, machine base installation, self-leveling floor underlayments, slab undersealing and slabjacking.

ChemGrout®

Widest Selection of Grouting Equipment in the World

▼ Shown from left to right: RACH-1504, RACH-15010, RACH-206, RACH-306



The Lightweight Solution for Tensioning and Testing



Saddles

All RACH-cylinders are equipped with bolt-on hollow removable saddles of hardened steel.



Lightweight Hand Pumps

The Enerpac composite lightweight hand pumps P-392 or P-802 make the optimal lightweight set.

Page: 62

- Hollow plunger design allows for both pull and push forces
- Composite bearings increase cylinder life and sideload resistance
- Hard-Coat finish on all surfaces resists damage and extends cylinder life
- Floating center tube increases seal and product life
- Handles standard on all models
- Steel base plate and saddle for protection against load-induced damage
- Integral stop ring prevents plunger over-travel and is capable of withstanding the full cylinder capacity
- High strength return spring for rapid cylinder retraction
- CR-400 coupler and dustcap included on all models
- All cylinders meet ASME B-30.1 and ISO 10100 standards.



◀ An RACH-306 powered by a P-392 hand pump used to extract corroded carriage pins of refuse collection vehicles.

Cylinder Capacity @ 700 bar ton (kN)	Stroke (mm)	Model Number	Cylinder Effective Area (cm ²)
20 (229)	50	RACH-202	32,7
	100	RACH-204	32,7
	150	RACH-206	32,7
	200	RACH-208	32,7
	250	RACH-2010	32,7
30 (358)	50	RACH-302	51,1
	100	RACH-304	51,1
	150	RACH-306	51,1
	200	RACH-308	51,1
	250	RACH-3010	51,1
60 (596)	50	RACH-602	84,7
	100	RACH-604	84,7
	150	RACH-606	84,7
	200	RACH-608	84,7
	250	RACH-6010	84,7
100 (1157)	50	RACH-1002	164,6
	100	RACH-1004	164,6
	150	RACH-1006	164,6
	200	RACH-1008	164,6
	250	RACH-10010	164,6
150 (1588)	50	RACH-1502	225,8
	100	RACH-1504	225,8
	150	RACH-1506	225,8
	200	RACH-1508	225,8
	250	RACH-15010	225,8

Single-Acting, Aluminium Hollow Plunger Cylinders

Steel Base Plate Mounting Holes

Cylinder Model / Capacity ton	Bolt Circle U (mm)	Thread V (mm)	Thread Depth ¹⁾ Z (mm)
RACH-20	80	M6	12
RACH-30	110	M6	12
RACH-60	160	M6	12
RACH-100	220	M10	12
RACH-150	245	M10	12

¹⁾ Including Base Plate Height of 6 mm and four (4) base plate bolts M6.

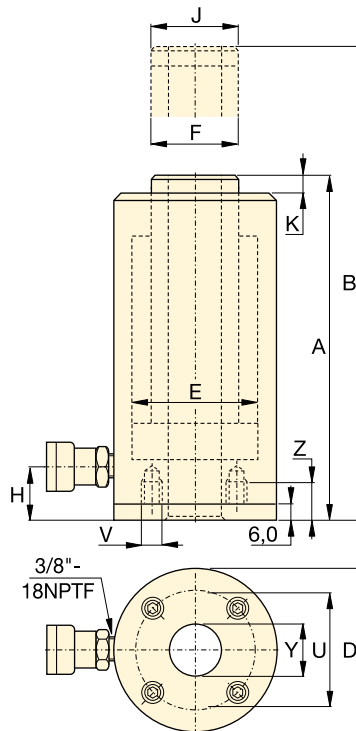

RACH Series

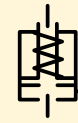

Capacity:

20 - 150 ton

Stroke:

50 - 250 mm

Center Hole Diameter:

27 - 79 mm

Maximum Operating Pressure:

700 bar

Oil Capacity (cm ³)	Collapsed Height A (mm)	Extended Height B (mm)	Outside Diameter D (mm)	Cylinder Bore Diameter E (mm)	Plunger Diameter F (mm)	Bottom to Advance Port H (mm)	Saddle Diameter J (mm)	Saddle Protrusion from Plunger K (mm)	Center Hole Diameter Y (mm)	Weight (kg)	Model Number
164	188	238	100	75	55	29	55	10	27	5,2	RACH-202
327	251	351	100	75	55	29	55	10	27	6,1	RACH-204
491	315	465	100	75	55	29	55	10	27	7,1	RACH-206
654	378	578	100	75	55	29	55	10	27	8,0	RACH-208
818	442	692	100	75	55	29	55	10	27	9,0	RACH-2010
256	208	258	130	95	70	29	70	10	34	8,0	RACH-302
511	267	367	130	95	70	29	70	10	34	9,5	RACH-304
766	333	483	130	95	70	29	70	10	34	11,2	RACH-306
1022	395	595	130	95	70	29	70	10	34	12,9	RACH-308
1277	458	708	130	95	70	29	70	10	34	14,5	RACH-3010
423	251	301	180	130	100	61	100	12	54	16,2	RACH-602
847	315	415	180	130	100	61	100	12	54	19,5	RACH-604
1270	380	530	180	130	100	61	100	12	54	25,6	RACH-606
1694	445	645	180	130	100	61	100	12	54	26,0	RACH-608
2117	510	760	180	130	100	61	100	12	54	29,6	RACH-6010
823	258	308	250	185	145	61	145	14	79	33,8	RACH-1002
1646	325	425	250	185	145	61	145	14	79	39,8	RACH-1004
2487	391	541	250	185	145	61	145	14	79	46,2	RACH-1006
3291	459	659	250	185	145	61	145	14	79	52,2	RACH-1008
4114	527	777	250	185	145	61	145	14	79	58,8	RACH-10010
1129	280	330	275	205	150	61	145	14	79	48,9	RACH-1502
2258	360	460	275	205	150	61	145	14	79	55,7	RACH-1504
3387	430	580	275	205	150	61	145	14	79	63,0	RACH-1506
4517	500	700	275	205	150	61	145	14	79	70,1	RACH-1508
5646	570	820	275	205	150	61	145	14	79	77,2	RACH-15010



XC-Series Cordless Hydraulic Pump

Extreme
Performance

Cordless
Convenience



ENERPAC 

▼ Shown: XC-1201



Performance of a Powered Pump. Portability of a Hand Pump.



G2535L Gauge

Minimize the risk of overloading and ensure long dependable service from your cordless pump.



Battery packs contain no cadmium, so they are environmentally friendly. Enerpac encourages recycling.



28-Volt Battery

The XC-28V with Lithium-Ion technology for maximum battery performance.



Battery Charger

1-hour quick charger.

XC-115VC	115 VAC
XC-230VC	230 VAC

- Lightweight design with integrated handle and carrying strap for portability
- Bladder reservoir prevents contamination and allows pump usage in any position
- Powerful ½ horsepower motor and 28 volt Lithium-Ion battery deliver exceptional speed and run time
- High-strength fiberglass reinforced composite shroud for superior durability in demanding job site environments
- Cordless technology eliminates tripping hazards found in other powered pumps



◀ Power and simplicity for the toughest jobs.

Cordless Hydraulic Pump



XC-Series Cordless Hydraulic Pump

The XC-Series cordless pump is ideal for jobs using small to medium size cylinders and hydraulic tools, and is compatible with over 140 Enerpac tools and cylinders. These cordless pumps combine the performance of a powered pump with the portability of a hand pump making them a perfect solution for remote applications with limited or no access to a power supply or for locations where corded solutions present trip hazards.

The Lithium-Ion battery provides superior run time, even under extreme job site conditions.*

- 279 cuts of 3/8" reinforcing bar using the WHC-750 cutter
- 112 lifts with the WR-5 spreader
- 44 splits on 1", grade 8 nuts using the NC-3241 nut splitter
- 28 lifts of an RC-104

The XC-Series cordless pump is CSA and CE compliant.

*Actual number of cycles per charge will vary depending on condition of tool, battery and ambient conditions.



XC Series



Reservoir Capacity:
60-120 in³

Flow at Rated Pressure:
15 in³/min.

Maximum Operating Pressure:
10,000 psi

- ① Outlet "Advance" Port
- ② Oil Fill (must use funnel)
- ③ User Adjustable Relief Valve Access Port
- ④ Directional Control Valve
- ⑤ Shoulder Strap Connection Points
- ⑥ Safety Lock Feature
- ⑦ On/Off Switch

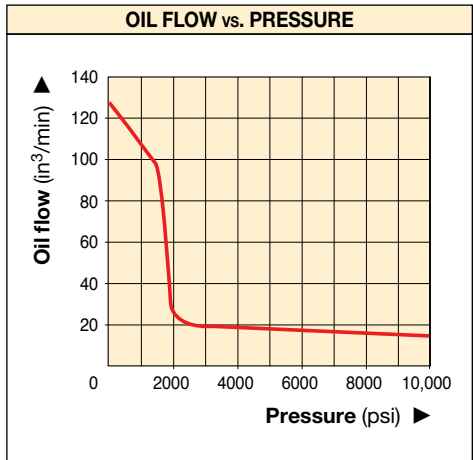
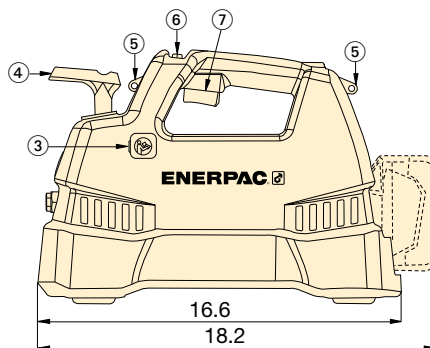
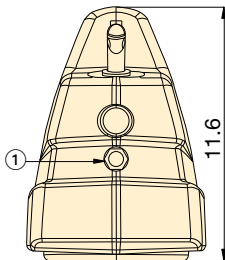
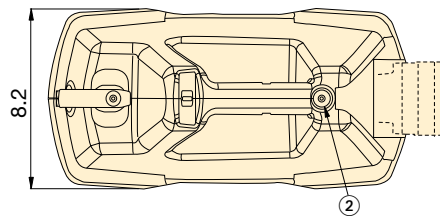

▼ Take the battery pump anywhere without power cords or air hoses.



▼ SELECTION CHART

Oil Capacity (in ³)	Model Number	Output Flow Rate (in ³ /min)			Valve Function	Charger Voltage (VAC)	Weight (lbs)
		No Load	2000 psi	10,000 psi			
60	XC-1201MB	125	30	15	3-way, 2-pos.	115	21.85
120	XC-1202MB	125	30	15			23.75
60	XC-1201ME	125	30	15	3-way, 2-pos.	230	21.85
120	XC-1202ME	125	30	15			23.75
60	XC-1201M*	125	30	15	3-way, 2-pos.	-	21.85
120	XC-1202M*	125	30	15			23.75

* Batteries and charger not included.

Cordless Hydraulic Pump



The Industrial Tools Line

Cylinders

- General Purpose
- Pancake
- Aluminum Lightweight
- Low Height
- Heavy-duty
- Hollow Plunger
- Industrial
- Pull
- Long Stroke
- Jacks
- Spread

Pumps

- Manual
- Electric Driven
- Compressed Air Driven
- Petrol Driven

System Components

- Hoses, Couplers, Oil
- Gauges, Adaptors
- Manifolds, Fittings

Valves

- 3-and 4-Way Directional
- Pressure and Flow Control

Presses

- Bench and Workshop
- Roll Frame Presses
- Arbor and C-Clamps

Pullers

- Master Pullers Sets
- Multi Purpose Puller Sets
- Posi Lock® Pullers

Tools

- Maintenance Sets
- Punches
- Machine Lifts
- Load Skates
- Cutters
- Pipe Benders

Bolting Tools

- Nut Splitters
- Flange/Wedge Spreaders
- Flange Alignment Tools
- Torque Wrenches
- Hydraulic Wrench Pumps
- Twin Safety Hoses

Integrated Hydraulic Solutions

- Stage Lift Systems
- Synchronous Lifting Systems
- Synchronous Hoisting Systems
- Strand Jacking Systems

Enerpac Worldwide Locations

Australia and New Zealand

Actuant Australia Ltd.
Block V Unit 3, Regents Park Estate
391 Park Road,
Regents Park NSW 2143
(P.O. Box 261) Australia
T +61 297 438 988
F +61 297 438 648
sales-au@enerpac.com

Brazil

Power Packer do Brasil Ltda.
Rua dos Inocentes, 587
04764-050 - Sao Paulo (SP)
T +55 11 5687 2211
F +55 11 5686 5583
Toll Free: 0800 891 5770
vendabrasil@enerpac.com

Canada

Actuant Canada Corporation
6615 Ordan Drive, Unit 14-15
Mississauga, Ontario L5T 1X2
T +1 905 564 5749
F +1 905 564 0305
Toll Free:
T +1 800 268 4987
F +1 800 461 2456
customer.service@actuant.com

China (Taicang)

Actuant (China) Industries Co.Ltd.
No. 6 Nanjing East Road,
Taicang Economic Dep Zone
Jiangsu, China
T +86 0512 5328 7500
F +86 0512 5335 9690
Toll Free:
T +86 400 885 0369
sales-cn@enerpac.com

France, Switzerland, North Africa and French speaking African countries

ENERPAC
Une division d'ACTUANT France S.A.S.
ZA de Courtaboeuf
32, avenue de la Baltique
91140 VILLEBON /YVETTE
France
T +33 1 60 13 68 68
F +33 1 69 20 37 50
sales-fr@enerpac.com

Germany and Austria

ENERPAC GmbH
P.O. Box 300113
D-40401 Düsseldorf
Willstätterstrasse 13
D-40549 Düsseldorf, Germany
T +49 211 471 490
F +49 211 471 49 28
sales-de@enerpac.com

India

ENERPAC Hydraulics Pvt. Ltd.
No. 1A, Peenya Industrial Area
IInd Phase, Bangalore, 560 058, India
T +91 80 40 792 777
F +91 80 40 792 792
sales-in@enerpac.com

Italy

ENERPAC S.p.A.
Via Canova 4
20094 Corsico (Milano)
T +39 02 4861 111
F +39 02 4860 1288
sales-it@enerpac.com

Japan

Applied Power Japan LTD KK
Besshocho 85-7
Kita-ku, Saitama-shi 331-0821, Japan
T +81 48 662 4911
F +81 48 662 4955
sales-jp@enerpac.com

Middle East, Egypt and Libya

ENERPAC Middle East FZE
Office 423, LOB 15
P.O. Box 18004, Jebel Ali, Dubai
United Arab Emirates
T +971 (0)4 8872686
F +971 (0)4 8872687
sales-ua@enerpac.com

Russia

Rep. office Enerpac
Russian Federation
Admiral Makarova Street 8
125212 Moscow, Russia
T +7 495 98090 91
F +7 495 98090 92
sales-ru@enerpac.com

Singapore

Actuant Asia Pte Ltd.
83 Joo Koon Circle, Singapore 629109
T +65 68 63 0611
F +65 64 84 5669
Toll Free:
T +1800 363 7722
sales-sg@enerpac.com

South Korea

Actuant Korea Ltd.
3Ba 717, Shihwa Industrial Complex
Jungwang-Dong, Shihung-Shi,
Kyunggi-Do
Republic of Korea 429-450
T +82 31 434 4506
F +82 31 434 4507
sales-kr@enerpac.com

Spain and Portugal

ENERPAC SPAIN, S.L.
Avda. Los Frailes, 40 – Nave C & D
Pol. Ind. Los Frailes
28814 Daganzo de Arriba
(Madrid) Spain
T +34 91 884 86 06
F +34 91 884 86 11
sales-es@enerpac.com

Sweden, Denmark, Norway, Finland and Iceland

Enerpac Scandinavia AB
Fabriksgatan 7
412 50 Gothenburg, Sweden
T +46 (0) 31 799 0281
F +46 (0) 31 799 0010
scandinavianinquiries@enerpac.com

The Netherlands, Belgium, Luxembourg, Central and Eastern Europe, Baltic States, Greece, Turkey and CIS countries

ENERPAC B.V.
Galvanistraat 115
6716 AE Ede
P.O. Box 8097
6710 AB Ede
The Netherlands
T +31 318 535 911
F +31 318 535 848
sales-nl@enerpac.com

South Africa and other English speaking African countries

ENERPAC AFRICA (PTY) Ltd.
Cambridge Office Park, Block E
5 Bauhinia Avenue
Highveld Techno Park, Centurion
Republic of South-Africa
T 0027 (0) 12 940 0656
sales-za@enerpac.com

United Kingdom and Ireland

ENERPAC Ltd.,
Bentley Road South
Darlaston, West Midlands
WS10 8LQ
England
T +44 (0)121 50 50 787
F +44 (0)121 50 50 799
sales-uk@enerpac.com

USA, Latin America and Caribbean

ENERPAC World Headquarters
P.O. Box 3241
Milwaukee, WI 53201-3241 USA
N86 W12500 Westbrook Crossing
Menomonee Falls, Wisconsin 53051
T +1 262 293 1600
F +1 262 293 7036
User inquiries:
+1 800 433 2766
Distributor inquiries/orders:
+1 800 558 0530
+1 800 628 0490
Technical inquiries:
techservices@enerpac.com
sales-us@enerpac.com

Your Enerpac Distributor:

e-mail: info@enerpac.com
Internet: www.enerpac.com

Attachment B -Material Datasheets-

PORTLAND CEMENT

PRODUCT NO. 1124-31, -47, -94

PRODUCT DESCRIPTION

QUIKRETE® Portland Cement is a high quality Portland cement meeting ASTM C 150 Type I.

PRODUCT USE

QUIKRETE® Portland Cement is used for making high strength repair mortars, concrete and for any other applications requiring Type I Portland cement. In many locations the product also meets ASTM C 150 Type II. Consult your supplying plant to confirm compliance with ASTM C 150 Type II.

SIZES

- QUIKRETE® Portland Cement
 - 31 lb (14 kg) bags
 - 47 lb (21.3 kg) bags
 - 94 lb (42.6 kg) bags
 - 40 kg (88 lb) bags
 - 42 kg (93 lb) bags

YIELD

• Yield depends on application. For concrete mixes: Five to six 94 lb (42.6 kg) bags of QUIKRETE® Portland Cement is typically used with appropriate proportions of sand and gravel to produce 1 cu. yd. (0.8 m³) of concrete.

TECHNICAL DATA

QUIKRETE® Portland Cement complies with ASTM C 150 Type I and in many locations also complies with ASTM C 150 Type II. The product is used in a variety of construction materials. Typical mix designs for some applications are listed below:

Concrete Mix

- 1 Part QUIKRETE® Portland Cement
- 2 Parts QUIKRETE® All-Purpose Sand (ASTM C-33)
- 3 Parts QUIKRETE® All-Purpose Gravel (ASTM C-33)

Mortar Mix (Type S, per ASTM C-270)

- 1 Part QUIKRETE® Portland Cement
- 1/2 Part QUIKRETE® Hydrated Lime -Type S
- 3-1/2 to 4-1/2 Parts QUIKRETE® Masonry Sand (ASTM C-144)

Scratch and Brown Coat Stucco Mix (per ASTM C-926)

- 1 Part QUIKRETE® Portland Cement
- 1/2 Part QUIKRETE® Hydrated Lime (Type S)
- 4-1/2 to 6 Parts QUIKRETE® Washed Plaster Sand (ASTM C-897)

DIVISION 3

Cement
03 05 00



INSTALLATION

Installation methods are specific for each type of product.

PRECAUTIONS

- The following points apply to all products made from Portland cement:
- Protect from freezing for at least 24-48 hr.
 - Use the minimum amount of water necessary to achieve the desired consistency. Adding too much water will weaken the product.
 - Keep the product damp for several days to obtain proper curing.

WARRANTY

The QUIKRETE® Companies warrant this product to be of merchantable quality when used or applied in accordance with the instructions herein. The product is not warranted as suitable for any purpose or use other than the general purpose for which it is intended. Liability under this warranty is limited to the replacement of its product (as purchased) found to be defective, or at the shipping companies' option, to refund the purchase price. In the event of a claim under this warranty, notice must be given to The QUIKRETE® Companies in writing. This limited warranty is issued and accepted in lieu of all other express warranties and expressly excludes liability for consequential damages.

The QUIKRETE® Companies
One Securities Centre
3490 Piedmont Rd., NE, Suite 1300, Atlanta, GA 30305
(404) 634-9100 • Fax: (404) 842-1425

* Refer to www.quikrete.com for the most current technical data, MSDS, and guide specifications



CA Contractor License # 988368 Class A

Emergency Action Plan

**Montecito Debris Flow Mitigation Project
Santa Barbara County, California**

-October 24, 2018-

Table of Contents

1.0 EMERGENCY ACTION PLAN DESCRIPTION	3
2.0 MEDICAL FACILITY & EMERGENCY INFORMATION	4
3.0 EMERGENCY PROTOCOL	5
4.0 PRECIPITATION EVENT	5
4.1 SOURCES OF WEATHER DATA – MONITORING POTENTIAL EVENTS	5
4.1.1 NWS Montecito #2 Weather Station (RAWS).....	6
4.1.2 NOAA Weather Radio All Hazards	6
4.1.3 Wireless Emergency Alerts.....	6
4.2 EMERGENCY ACTION PLAN TRIGGERING THRESHOLDS	7
4.3 EVACUATION PROTOCOL.....	7
4.4 REMOBILIZING AFTER AN EVACUATION EVENT	7
5.0 FIRE EVENT	ERROR! BOOKMARK NOT DEFINED.
6.0 PERSONNEL HEALTH AND SAFETY EVENT	8

Attachments

Project Map - Access Routes and Evacuation Points

1.0 EMERGENCY ACTION PLAN DESCRIPTION

Access Limited Construction (ALC) has prepared this Emergency Action Plan to document the protocol for responding to emergency scenarios during the construction and maintenance of debris retention nets at locations in Buena Vista Canyon, Hot Springs Canyon, Cold Springs Canyon, San Ysidro Canyon, and Romero Canyon in Montecito, California. This comprehensive emergency action plan has been developed based on the experience of Access Limited Construction personnel and a detailed understanding of the project. The plan will be implemented as a part of our proposed work plans for the installation, accumulated debris management, maintenance, and removal of these debris nets.

Access Limited Construction has visited the site with the project team and is familiar with each work area. The protocols detailed in this plan were developed as a result of the site visits and conversations and correspondence with the supporting team identified in this plan.

We recognize the inherent risk posed by working in active debris flow channels, as well as the need to perform the construction work to provide emergency risk mitigation and prevention to the Community of Montecito. The site-specific emergency action plans we have developed for each debris retention net work site reflect an organized, and carefully planned approach to minimizing the risks to the health and safety of personnel, as well as minimizing risks to the environment during the project.

Given the unique work locations in active stream channels subject to debris flow hazards, Access Limited Construction recognizes that an Emergency Action Plan is a prudent and necessary part of this project. Accordingly, we have developed a written procedure detailing the criteria for enacting the response to a potential hazard event during construction activities at the watershed locations proposed for debris flow mitigation. This plan is an integral part of our Master Work Plan for this project. We are familiar with the Santa Barbara County Office of Emergency Management and have incorporated portions of their emergency plan into our response protocol.

We have established a protocol that reflects a temporal response based on the precipitation forecast. The protocol establishes demobilization from the work area via helicopter or physically traversing out of the stream channel and securing equipment and materials on high ground above inundation areas (Evacuation Points). We have identified access routes from the major roadways to the ingress/egress points to each work area. We have identified safe landing zones for rapid removal of personnel, equipment, and materials via aerial transport. These are graphically presented as a part of this document.

2.0 MEDICAL FACILITY & EMERGENCY INFORMATION

Hospital Santa Barbara Cottage Hospital Emergency Room

400 W Pueblo St, Santa Barbara, CA 93105

(805) 682-7111

Urgent Care Action Urgent Care Medical Center

1046 Coast Village Road, Montecito, CA 93108

(415) 886-4952

Contact List

Access Limited Office	805-592-2230
Access Limited Vice President: Kevin Wiesman	517-605-6292
Access Limited Project Manager: Simon Boone	540-420-2678
Access Limited Superintendent: Samuel Geiges	541-778-3576
Access Limited Crew Foreman	
Crew 1 – Foreman: Jon Simpson	406-531-5508
Crew 2 – Foreman: Todd Ferryman	805-451-8549
Crew 3 – Foreman: Evan Langenbach	805-550-1448
Crew 4 – Foreman: Ernie Glynn	805-714-1185

3.0 EMERGENCY PROTOCOL

The response protocol for precipitation related events will be similar for work sites in each canyon where debris retention nets are being installed. The project map attached to this document shows the access routes and the ingress/egress points where equipment and material will be initially mobilized to the work areas via aerial transport as described in the Master Work Plan.

The Site Superintendent will be responsible for overall Site Safety and will have absolute authority to enact the emergency response protocols detailed below. The Site Superintendent will be supported by the Project Manager and the Home Office Staff in monitoring data sources and decision making regarding the triggering event to enacting the emergency response protocols.

The primary safety measure in place for this project will be the on-standby helicopter for the duration of the project. The helicopter pilot will be able to communicate with the Site Superintendent at all times via low frequency radio. As detailed in the Master Work Plan, all ingress/egress of equipment and materials will be by aerial transport via helicopter. Personnel will typically access the work areas via existing hiking trails but can ingress/egress via helicopter long line if necessary. The helicopter pilot will be familiar with the location of each work site and will be able to rapidly navigate to any site as a part of this Emergency Action Plan (EAP).

Project Foremen will be in constant communication with the Site Superintendent via low frequency hand held radios. At the point of Mobilization to each new work site, communications will be tested and any accommodations necessary to ensure clear communication between site personnel and the Site Superintendent will be enacted. The Project Foremen will also be able to communicate with the helicopter, if necessary. Hand signals are typically used to communicate direction during long line operations to raise and lower loads via aerial transport.

The sections below detail the protocols for events that would require the enactment of this Emergency Action Plan.

4.0 PRECIPITATION EVENT

The primary hazard identified for this project is precipitation induced debris flows impacting the work areas. The nature of the project is installing debris flow mitigating retention nets in stream channels identified as subject to debris flows. As a result, we have developed a response protocol that considers the precipitation forecast and provides a planned approach to securing personnel, equipment, and construction materials in a safe location prior to anticipated elevated debris flow risk scenarios.

The protocol for enacting the EAP in response to a predicted precipitation event will involve the following steps:

1. Continually monitor sources of weather data
2. Analyze weather data in relation to EAP Triggering Thresholds
3. If any of the Triggering Thresholds are reached, enact Evacuation Protocol
4. Follow Evacuation Protocol

4.1 Sources of Weather Data – Monitoring Potential Events

The primary source of weather data relied upon for this protocol is the National Weather Service (NWS) which is a part of the Federal National Oceanic and Atmospheric Administration (NOAA).

The project site is within the service area of the Los Angeles/Oxnard NWS local forecast office. These following sources of weather data will be monitored continually by the Site Superintendent and Home Office support staff. The precipitation outlook will be discussed at each daily safety meeting prior to crews mobilizing to the specific work areas.

4.1.1 NWS Montecito #2 Weather Station (RAWS)

The nearest weather data station to the project that is utilized by the LA/O NWS office is the MONTECITO #2 (MOIC1) weather station. It is located at Latitude: 34.445°N, Longitude: 119.625833°W, Elevation: 285-ft and is identified on the Project Map.

The NWS Forecast website for this station can be accessed at this address:

<https://forecast.weather.gov/MapClick.php?lat=34.4217&lon=-119.7097#.W7PrX2hKiUI>

This website provides a 7-day forecast, along with specific forecast formats.

The Quantitative Precipitation forecast is particularly useful to this EAP. It can be accessed at this address:

https://www.wrh.noaa.gov/total_forecast/getprod.php?afos=xxxqpslox&wfo=lox&version=0&print=yes&toggle=dictionary&new=1&font=150

The Quantitative Precipitation Forecast is provided for a 7-day outlook in 3hr and 6hr increments. Peak 1-HR Precipitation Rates for the Foothills/Mountains above Montecito are listed, along with the predicted convective (thunderstorm) activity during the forecast period.

The Historical Weather Data webpage for this station can be accessed here:

<https://www.wrh.noaa.gov/mesowest/getobext.php?wfo=lox&sid=MOIC1&num=72&raw=0>

The Historical Weather Data page lists data including Accumulated Precipitation by the hour.

The NWS Area Forecast Discussion is also a valuable source of weather data that provides synopsis of recent events as well as a synopsis of short term forecasts. It can be accessed here:

<https://forecast.weather.gov/product.php?site=LOX&issuedby=LOX&product=AFD&format=CI&version=1&glossary=1>

4.1.2 NOAA Weather Radio All Hazards

NOAA Weather Radio All Hazards (NWR) is a nationwide network of radio stations broadcasting continuous weather information directly from the nearest National Weather Service office. NWR broadcasts official Weather Service warnings, watches, forecasts and other hazard information 24 hours a day, 7 days a week.

Broadcasts are found in the VHF public service band at these seven frequencies (MHz):

162.400 162.425 162.450 162.475 162.500 162.525 162.550

4.1.3 Wireless Emergency Alerts

Access Limited Construction has contacted the NWS to be placed on their notification list for Alert Messages for Flash Flooding and Debris Flows

4.2 Emergency Action Plan Triggering Thresholds

The National Weather Service uses thresholds developed by the United States Geological Survey (USGS) for post-burn areas as guidance for issuing watches and warnings of possible flash floods and debris flows. The USGS develops these thresholds based on statistical occurrences of debris flows and associated rain rates for burn areas that are less than 2 years old.

The source of this information is a document entitled NWS Debris Flow Warning System and can be accessed here:

http://www.scag.ca.gov/programs/Documents/Earthquake/RAFwebinar_NWSdebrisFlowWarningSystem.pdf

The threshold used by the NWS is shown below:

Rainfall Rate Thresholds Used to Determine Likelihood of Debris Flows In and Near Recent Burn Areas	15 min	0.20 in
	30 min	0.30 in
	1 hr	0.50 in
	3 hr	1.00 in
	6 hr	1.40 in
	12 hr	1.90 in

High intensity, short duration rainfall rates found to be primary cause of debris flows. Rates produced by ordinary thunderstorms.

4.3 Evacuation Protocol

These thresholds shown in 4.2 above will be the triggering thresholds used by Access Limited Construction as a part of this protocol. If any precipitation event is forecast within 48-hours, it will be assessed for prediction of rainfall intensities approaching these thresholds. If any thunderstorm activity is forecast which could produce high rainfall intensities approaching or exceeding these thresholds, the Evacuation Protocol (EP) will be enacted by the Site Superintendent.

The EP will require a minimum of 1 full working day if there are the anticipated 4 active crew sites occupied at the time. The execution period may be shortened if there are less than 4 sites being actively occupied at the time the protocol is engaged.

The Evacuation Protocol will be orchestrated by removing personnel, equipment, and materials out of the debris flow inundation zones within the drainages. The project map identifies 2 safe landing zones on Camino Cielo which would be evacuation points for personnel, equipment, and materials. The purpose of choosing evacuation points on Camino Cielo is to simplify as much as possible the protocol, and to evacuate to a position that is not subject to the debris flow and flash flooding risk in lower elevations. The helicopter on standby will be stationed at a Landing Zone (LZ) on Camino Cielo to mobilize to each work area. This will allow flight paths for evacuation to not cross areas with occupied dwellings or areas with high volumes of air traffic.

After executing the Evacuation Protocol, Access Limited Construction Home Office Staff and the Site Superintendent will ensure that project personnel are provided accommodations in an area not subject to flash flood or debris flow risk.

4.4 Remobilizing after an Evacuation Event

Once the Evacuation Protocol is completely executed, Access Limited Construction Home

Office Staff and the Site Superintendent will monitor weather conditions to assess the requirements for remobilization. When remobilization is deemed acceptable, the work areas will be inspected to assess the feasibility of resuming work.

5.0 PERSONNEL HEALTH AND SAFETY EVENT

Given the remote nature of the work areas, it is a necessary and prudent part of this Emergency Action Plan to document a protocol for responding to a personnel health and safety event. The resources available at the jobsite for responding to this type incident will include the on standby helicopter and a helicopter rescue basket. Due to the restricted access of the work sites, it will likely not be possible to land the helicopter at the work area. The protocol for evacuating personnel requiring medical attention will be as follows:

1. The Crew Foreman at the work area will assess the medical need. If the Foreman has a medical need, the crew will assist in assessing the medical need.
2. The Site Superintendent will be contacted to report the medical need and will summon the helicopter to the appropriate work area, if necessary.
3. The personnel requiring medical attention will be packaged into a helicopter rescue basket and transported to the Landing Zone for subsequent transport to the nearest medical facility.

Attachment A -Project Map-

Montecito Debris Flow Mitigation Project Map

Legend

Access Routes
Ingress/Egress Points
Safe Landing Zones

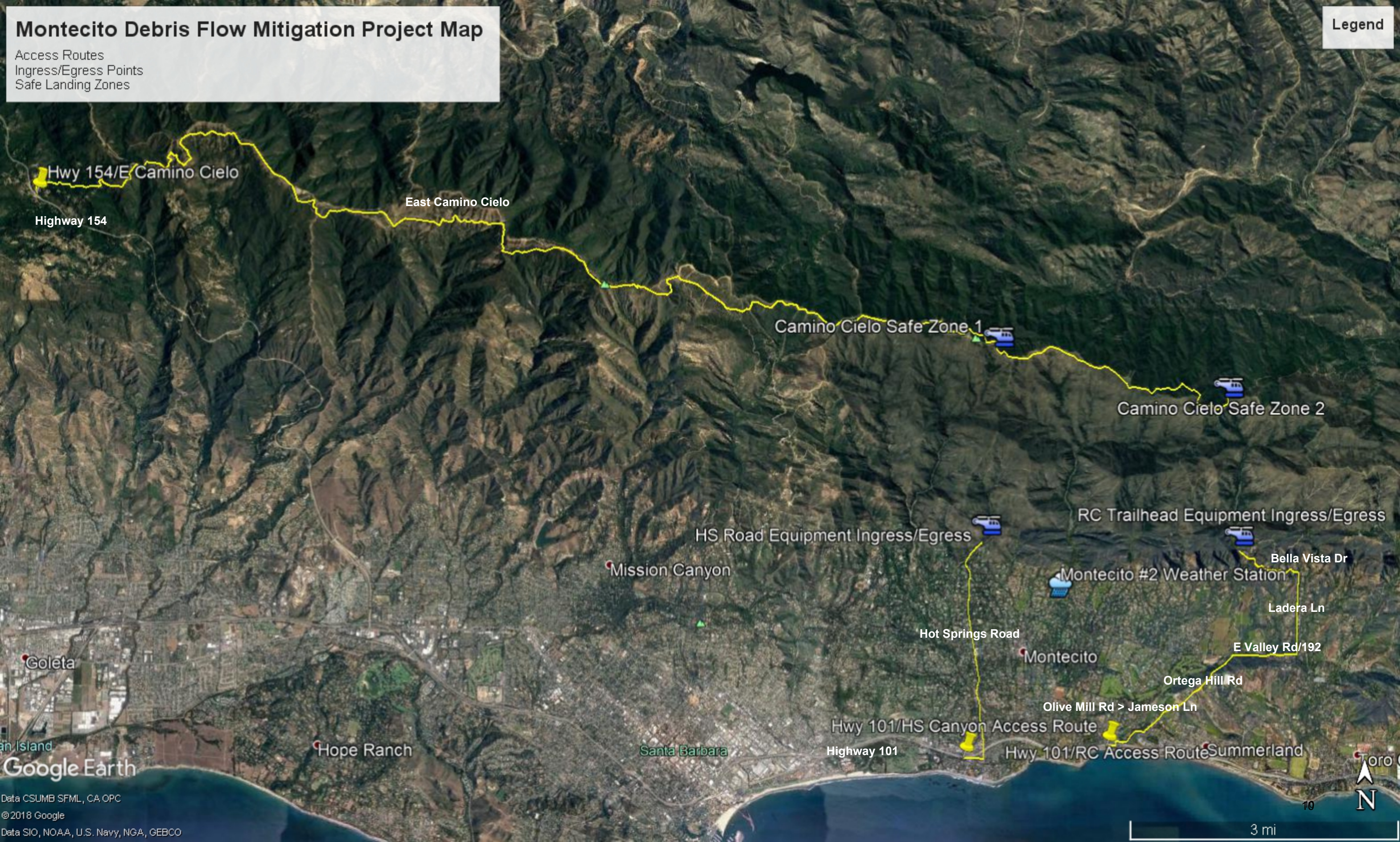

Hwy 154/E Camino Cielo

Highway 154

East Camino Cielo

Camino Cielo Safe Zone 1

Camino Cielo Safe Zone 2

HS Road Equipment Ingress/Egress

RC Trailhead Equipment Ingress/Egress

Mission Canyon

Montecito #2 Weather Station

Bella Vista Dr

Ladera Ln

Goleta

Hot Springs Road

Montecito

E Valley Rd/192

Hope Ranch

Santa Barbara

Hwy 101/HS Canyon Access Route

Ortega Hill Rd

Olive Mill Rd > Jameson Ln

Highway 101

Hwy 101/RC Access Route

Summerland

Google Earth

Data CSUMB SFML, CA OPC
©2018 Google
Data SIO, NOAA, U.S. Navy, NGA, GEBCO

3 mi



Montecito Debris Flow Mitigation Project Map

Legend

- Access Routes
- Ingress/Egress Points
- Safe Landing Zones

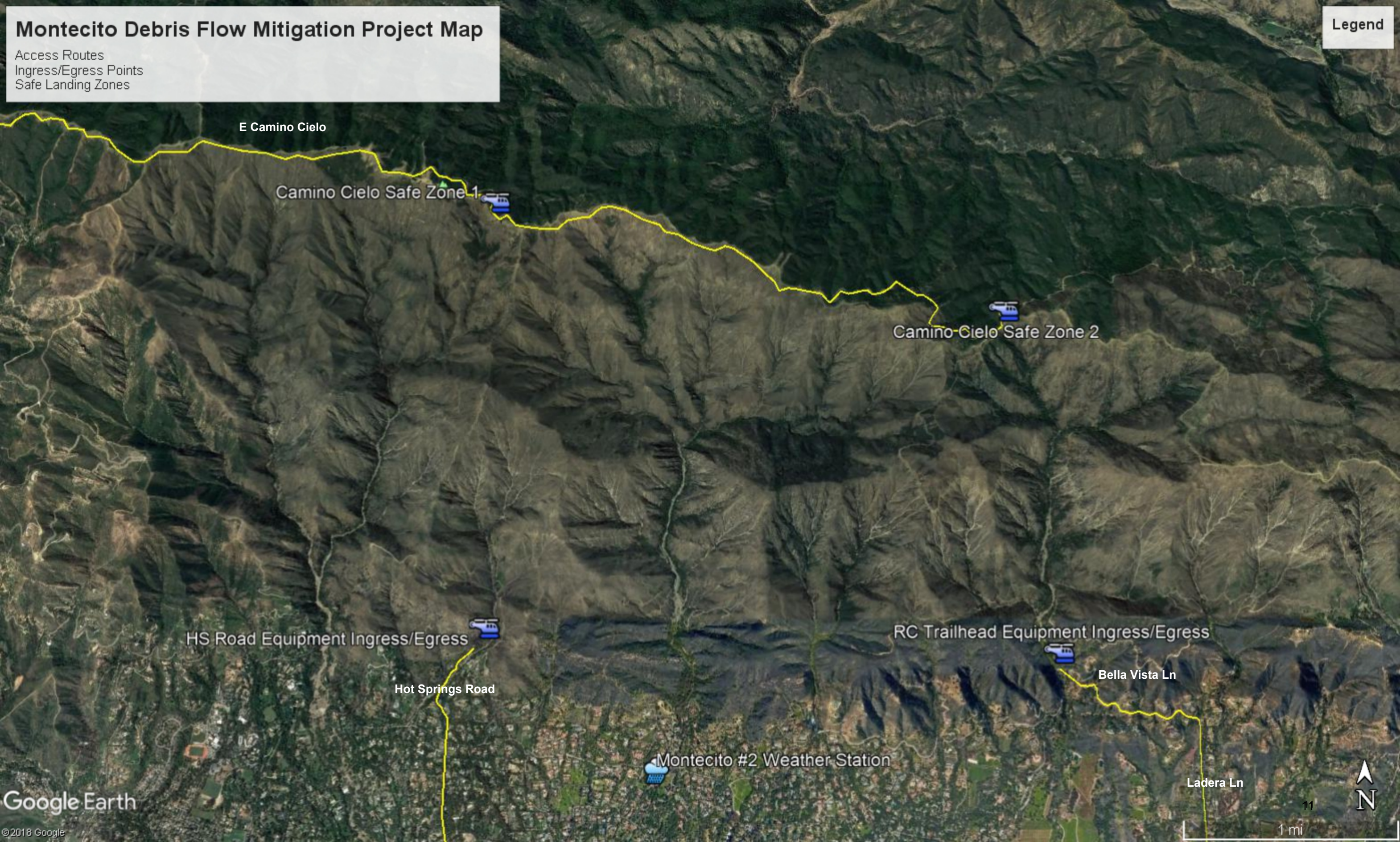

E Camino Cielo

Camino Cielo Safe Zone 1

Camino Cielo Safe Zone 2

HS Road Equipment Ingress/Egress

RC Trailhead Equipment Ingress/Egress

Hot Springs Road

Montecito #2 Weather Station

Bella Vista Ln

Ladera Ln

